

# Ultima Compact FreeCool

**Free Cooling Chiller  
75kW - 450kW**

**R407C**



# TECHNICAL MANUAL



FM00542

EMS52086

## About Airedale Products & Customer Services

### WARRANTY

All AIAC products or parts (non consumable) supplied for installation within the UK mainland and commissioned by an AIAC engineer, carry a full Parts & Labour warranty for a period of 12 months from the date of commissioning or 18 months from the date of despatch, whichever is the sooner.

Parts or Equipment supplied by AIAC for installation within the UK or for Export that are properly commissioned in accordance with AIAC standards and specification, not commissioned by an AIAC engineer; carry a 12 month warranty on non consumable Parts only from the date of commissioning or 18 months from the date of despatch, whichever is the sooner.

Parts or equipment installed or commissioned not to acceptable AIAC standards or specification invalidate all warranty.

### WARRANTY IS ONLY VALID IN THE EVENT THAT

In the period between delivery and commissioning the equipment: is properly protected & serviced as per the AIAC installation & maintenance manual provided where applicable the glycol content is maintained to the correct level.

In the event of a problem being reported and once warranty is confirmed as valid under the given installation and operating conditions, the Company will provide the appropriate warranty coverage (as detailed above) attributable to the rectification of any affected Airedale equipment supplied (excluding costs for any specialist access or lifting equipment that must be ordered by the customer).

Any spare part supplied by Airedale under warranty shall be warranted for the unexpired period of the warranty or 3 months from delivery, whichever period is the longer.

To be read in conjunction with the Airedale Conditions of Sale - Warranty and Warranty Procedure, available upon request.

### CAUTION



Warranty cover is not a substitute for maintenance. Warranty cover is conditional to maintenance being carried out in accordance with the recommendations provided during the warranty period. Failure to have the maintenance procedures carried out will invalidate the warranty and any liabilities by Airedale International Air Conditioning Ltd.

### SPARES

A spares list for 1, 3 and 5 years will be supplied with every unit and is also available from our Spares department on request.

### TRAINING

As well as our comprehensive range of products, Airedale offers a modular range of Refrigeration and Air Conditioning Training courses, for further information please contact Airedale.

### CUSTOMER SERVICES

For further assistance, please e-mail: [enquiries@airedale.com](mailto:enquiries@airedale.com) or telephone:

<b>UK Sales Enquiries</b>	+ 44 (0) 113 238 7789	<a href="mailto:enquiries@airedale.com">enquiries@airedale.com</a>
<b>International Enquiries</b>	+ 44 (0) 113 239 1000	<a href="mailto:enquiries@airedale.com">enquiries@airedale.com</a>
<b>Spares Hot Line</b>	+ 44 (0) 113 238 7878	<a href="mailto:spares@airedale.com">spares@airedale.com</a>
<b>Airedale Service</b>	+ 44 (0) 113 239 1000	<a href="mailto:service@airedale.com">service@airedale.com</a>
<b>Technical Support</b>	+ 44 (0) 113 239 1000	<a href="mailto:tech.support@airedale.com">tech.support@airedale.com</a>
<b>Training Enquiries</b>	+ 44 (0) 113 239 1000	<a href="mailto:marketing@airedale.com">marketing@airedale.com</a>

For information, visit us at our Web Site: [www.airedale.com](http://www.airedale.com)

AIAC Ltd. endeavours to ensure that the information in this document is correct and fairly stated, but none of the statements are to be relied upon as a statement or representation of fact. AIAC Ltd. does not accept liability for any error or omission, or for any reliance placed on the information contained in this document.

The development of Airedale products and services is continuous and the information in this document may not be up to date. It is important to check the current position with AIAC Ltd. at the address stated. This document is not part of a contract or licence unless expressly agreed.

No part of this document may be reproduced or transmitted in any form or by any means, electronic or mechanical, including photocopying, recording, or information storage and retrieval systems, for any purpose other than the purchaser's personal use, without the express written permission of AIAC Ltd.

© 2018 Airedale International Air Conditioning Limited. All rights reserved. Printed in the UK.

## Contents

<b>Health and Safety</b> .....	<b>4</b>
<b>Environmental Considerations</b> .....	<b>5</b>
Freeze Protection.....	5
Environmental Policy.....	5
<b>General Description</b> .....	<b>7</b>
Unit Identification .....	7
Standard Features .....	8
Optional Extras – Energy Saving .....	11
Optional Extras – General.....	11
<b>Design Features &amp; Information</b> .....	<b>14</b>
Free Cooling .....	14
Electronic Expansion Valves (EEV) .....	15
Minimum System Water Volume Calculations .....	16
<b>Controls</b> .....	<b>17</b>
General Description .....	17
Temperature control.....	18
Monitoring .....	19
Alarm Handling .....	19
Networking .....	19
Standard Features .....	20
Optional Features .....	20
<b>Performance Data</b> .....	<b>21</b>
Capacity Data – DX Mechanical Cooling .....	21
Capacity Data – Free Cooling .....	24
Operating Limits.....	32
Glycol Data .....	32
Waterside Pressure Drops .....	33
Pump Packages.....	36
<b>Sound Data</b> .....	<b>38</b>
Measurement of Sound Data .....	38
Global & Directional Sound Level .....	39
<b>General Specification</b> .....	<b>43</b>
Mechanical Data .....	43
Electrical Data.....	47
<b>Dimension Data</b> .....	<b>53</b>
Single Row Fans - /1.....	53
Double Row Fans - /2 .....	54
<b>Installation Data</b> .....	<b>55</b>
Weights, Point Loadings & Centre of Gravity (C of G) .....	55
Double Row Fans - /2 .....	56
Unit Lifting.....	57
Positioning .....	58
Anti vibration mounting (optional).....	59
Water System .....	60
Standard Recommended Installation .....	60
Electrical .....	61
Interconnecting Wiring .....	62

## Health and Safety

**IMPORTANT** The information contained in this manual is critical to the correct operation and maintenance of the unit and should be read by all persons responsible for the installation, commissioning and maintenance of this Airedale unit.

### Safety

The equipment has been designed and manufactured to meet international safety standards but, like any mechanical/electrical equipment, care must be taken if you are to obtain the best results.

- CAUTION** ▼ 1 **Installation, service and maintenance of Airedale equipment should only be carried out by technically trained competent personnel.**
- CAUTION** ▼ 2 **When working with any air conditioning units ensure that the electrical isolator is switched off prior to servicing or repair work and that there is no power to any part of the equipment.**
- 3 Also ensure that there are no other power feeds to the unit such as fire alarm circuits, BMS circuits etc.
- 4 Electrical installation commissioning and maintenance work on this equipment should be undertaken by competent and trained personnel in accordance with local relevant standards and codes of practice.
- 5 The refrigerant used in this range of products is classified under the COSHH regulations as an irritant, with set Workplace Exposure Levels (WEL) for consideration if this plant is installed in confined or poorly ventilated areas.
- 6 A full hazard data sheet in accordance with COSHH regulations is available should this be required.

### Protective Personal Equipment

Airedale recommends that personal protective equipment is used whilst installing, maintaining and commissioning equipment.

### Refrigerant Warning

The Airedale Ultima Freecool uses R407C refrigerant which is a high pressure refrigerant. It requires careful attention to proper storage and handling procedures.

Use on manifold gauge sets designed for use with R407C refrigerant. Use only refrigerant recovery units and cylinders designed for high pressure refrigerants.

R407C must only be charged in the liquid state to ensure correct blend makeup.

The refrigerant must be stored in a clean, dry area away from sunlight. The refrigerant must never be stored above 50°C.

### Manual Handling

Some operations when servicing or maintaining the unit may require additional assistance with regard to manual handling. This requirement is down to the discretion of the engineer. Remember do not perform a lift that exceeds your ability.

## Environmental Considerations

### FREEZE PROTECTION

Airedale recommends the following actions to help protect the unit during low temperature operation. This also includes the units subject to low ambient temperatures.

#### Units with supply water temperatures below +5°C

- Glycol is recommended when a supply water temperature of +5°C or below is required or when static water can be exposed to freezing temperatures.

#### Units subject to ambient temperatures lower than 0°C

- Glycol of an appropriate concentration <sup>(1)</sup> is used within the system to ensure adequate protection. Please ensure that the concentration is capable of protection at least 3°C lower than ambient.
- Water/glycol solution is constantly circulated through all waterside pipework and coils to avoid static water from freezing.
- Ensure that pumps are started and running even during shut down periods, when the ambient is within 3°C of the solution freeze point <sup>(1)</sup> (i.e. if the solution freezes at 0°C, the pump must be operating at 3°C ambient).
- Additional trace heating is provided for interconnecting pipework.

<sup>(1)</sup> Referrer to your glycol supplier for details

### ENVIRONMENTAL POLICY

It is our policy to:

- Take a proactive approach to resolve environmental issues and ensure compliance with regulatory requirements.
- Train personnel in sound environmental practices.
- Pursue opportunities to conserve resources, prevent pollution and eliminate waste.
- Manufacture products in a responsible manner with minimum impact on the environment.
- Reduce our use of chemicals and minimise their release to the environment.
- Measure, control and verify environmental performance through internal and external audits.
- Continually improve our environmental performance.

### CE Directive



Airedale certify that the equipment detailed in this manual conforms with the following EC Directives:

Electromagnetic Compatibility Directive (EMC)	<b>2014/30/EU</b>
Machinery Directive (MD)	<b>89/392/EEC version 2006/42/EC</b>
Pressure Equipment Directive (PED)	<b>2014/68/EU</b>
Ecodesign	<b>2009/125/EC</b>

To comply with these directives appropriate national & harmonised standards have been applied. These are listed on the Declaration of Conformity, supplied with each product.

#### Maximum and Minimum Operation Temperature (TS) and Pressure (PS)

Allowable Temperature range (TS) = Min -20°C to Max 120°C \*  
 Maximum Allowable Pressure (PS) = High Side 26 Barg

\*Based on the refrigerant temperature in the unit off state in the lowest permitted ambient temperature.

\*\*Based on the maximum allowable super-heated refrigerant temperature.

### Ecodesign Directive

Select units within the range are Ecodesign compliant for both process (SEPR) and comfort cooling (SSCEE) applications. Products sold outside of the EU are exempt from this directive. Please refer to your Airedale account manager for full details.



## General Description

### UNIT IDENTIFICATION

ULTIMA COMPACT FREE COOLING CHILLER	
<b>UCFC</b>	Ultima Compact FreeCool
<b>75 - 450</b>	Model Size (Expressed as Nominal Cooling in kW)
<b>D-</b>	Double Circuit - Standard Chiller
<b>DQ-</b>	Double Circuit - <b>Q</b> uiet Chiller
<b>DSQ-</b>	Double Circuit - <b>S</b> uper <b>Q</b> uiet Chiller
<b>2 - 16</b>	Number of Fans
<b>/1 or /2</b>	Single or Double Row of Fans
<b>Example</b>	<b>UCFC75DQ-2/1</b>

### INTRODUCTION

The Airedale range of Ultima Compact FreeCool air cooled liquid chillers covers the cooling capacity range 75kW to 450kW in 45 model sizes incorporating Standard **D**, Quiet **DQ** and Super Quiet **DSQ** variations.

Attention has been placed on maximising the unit's cooling and energy performance while keeping the footprint to an absolute minimum.

Refer to **Free Cooling**, on page 14 for further details.

### REFRIGERANTS

The range has been designed and optimised for operation with the ozone benign R407C refrigerant.

### CONSTRUCTION

The base is fabricated from galvanised steel to ensure a rigid, durable, weatherproof construction.

Unit panels are manufactured from galvanised sheet steel coated with epoxy baked powder paint to provide a durable and weatherproof finish.

Standard unit colour is Light Grey (RAL 7035).

Compressors and evaporator are mounted on a rigid galvanised heavy-duty sub frame. Fully weatherproofed electrical panels are situated at one end of the unit. Access to the compressors is via end panels adjacent to the electrical control panel.

A set of 4 collared eye bolts to BS4278 are supplied.

### Discharge Air Plenum - Condenser Fan

Constructed from galvanised sheet steel coated with epoxy baked powder paint, this plenum directs discharge air vertically, thus limiting a degree of air re-circulation and provides a degree of acoustic reduction in the horizontal plane; factory fitted. For details please contact Airedale.

Standard unit colour is Light Grey (RAL 7035).

## General Description

### STANDARD FEATURES

#### Standard Chiller - D

The Standard Ultima Compact FreeCool chiller comes complete with:

- **AIRE**Tronix Microprocessor Control with BMS capability
- Condenser Coil & integral Free Cooling Coil Assembly
- Plate Evaporator
- Evaporator Pad Heater
- Multiple Scroll Compressors
- Dual Independent Refrigeration Circuits
- Intelligent Head Pressure Control
- Compressor Enclosures
- Electronic Expansion Valve (EEV)
- 3 way modulating valve to control free cooling operation
- Butterfly shut off valve for free cooling coil isolation to allow for maintenance
- Water Flow Switch & Water Filter
- Sickle Bladed fans with Long Bellmouth 900 rpm
- Condenser Fan Discharge Plenum
- Connections for External Trace Heating (240V/500W available)
- A set of 4 collared eye bolts to BS4278

With all the features of the Standard range, the Quiet and Super Quiet chillers are available with additional features:

#### Quiet Chiller - DQ

- Fan speed reduced to 750 rpm

#### Super Quiet Chiller - DSQ

- Fan speed reduced to 570 rpm
- Acoustically lined compressor compartment
- Enhanced Refrigeration Condenser Coils



## General Description

### STANDARD FEATURES

#### Evaporator

Stainless steel high efficiency brazed plate heat exchanger(s) will allow optimum heat transfer between media. Each heat exchanger is insulated with closed cell polyurethane foam to Class 1 fire rating.

Water inlet and outlet are at the opposite end to the compressor (water inlet and outlet flanges are to PN16).

A self-regulating pad heater is fitted to the single evaporator and will protect against freeze up in ambient temperatures as low as -20°C.

Connections for External Trace Heating (230V/500W available).

#### Condenser

Large surface area coil(s) ideally positioned to optimise airflow and heat transfer, manufactured from refrigeration quality copper tubes with mechanically bonded aluminium fins.

#### Free Cooling Coil

Large surface area coil(s) ideally positioned to optimise airflow and heat transfer, manufactured from refrigeration quality copper tubes with mechanically bonded aluminium fins.

Spacing between condenser and free-cooling coils is provided for cleaning maintenance along with top access holes and drain holes to the base.

#### Fan & Motor Assembly - Condenser Fan

Sickle bladed fan assemblies with integral long bellmouth and fingerproof grille. Incorporate external rotor ac motor technology, to provide highly accurate discreet speed control, discharges air vertically. The fans offer maximum airflow performance while keeping sound levels to a minimum.

Each fan is speed controllable and operates from a 3 phase electrical supply.

Energy efficient Electronically Commutated (EC) fans are also available; **for further details, please contact Airedale.**

#### Head Pressure Control

3 phase head pressure controllers are fitted which modulate the fan speed to maintain a constant condensing pressure in the DX mechanical cooling mode and afford reductions in input power when overcooling in low ambients.

Additional refrigeration valves are fitted to allow DX mechanical and free cooling functions to operate simultaneously in order to maximise free cooling and minimise energy consumption.

#### Compressor

Scroll compressors comprising:

- Internal motor protection
- Internal pressure relief
- Non return valve
- External discharge temperature protection
- Oil sight glass
- Oil heater

Each Tandem / Trio set has an oil equalisation line.

The compressors are mounted to the rigid galvanised heavy duty sub-frame with the use of vibration reducing isolation.

## General Description

### STANDARD FEATURES

#### Refrigeration

Each refrigeration circuit is supplied with the following:

- Full operating charge of R407C
- Electronic Expansion Valve (EEV)
- Liquid line ball valve
- Discharge line ball valve
- Large capacity filter drier with replaceable cores
- Liquid line sight glass
- Low pressure switch with manual reset via microprocessor controller
- High pressure switch with manual reset
- Suction and liquid pressure transducers
- Valves for refrigeration head pressure control
- Compressor minimum differential pressure protection
- Pressure relief valve with integral rupture disc and indicator gauge URAC180 – 450, (Optional to UCFC75 – 160)

#### Water / Glycol

Each water glycol circuit is supplied with the following:

- Water Flow switch
- 3 way modulating valve to control free cooling operation
- Strategically placed automatic air vents
- Strategically placed drain valves
- Butterfly shut off valve for free cooling coil isolation to allow for maintenance
- Pressure transducers across evaporator to monitor water pressure drop
- Inlet water filter 20 mesh

#### Controls

As standard, the **AIRE**Tronix microprocessor controller can provide 2, 4 or 6 stages of capacity control, dependent upon model type.

Optionally, the controller is designed to provide capabilities for;

- Building Management Systems
- Networking
- Sequencing (Master/Slave and Run/Standby)

to meet all your system requirements, **please specify at order.**

For further details, refer to **Controls**, on page 17

---

## General Description

### STANDARD FEATURES

#### Electrical

Dedicated weatherproof electrical power and controls panels are situated at the end of the unit and contain:

- Emergency Stop fitted to controls compartment door
- Separate, fully accessible, controls compartment, allowing adjustment of control set points whilst the unit is operational
- Circuit breakers for protection of all major unit components
- Separate door locking electrical isolation for each mains compartment
- Electrical terminals for external evaporator pipework trace heating (230V/500W) are provided.

**CAUTION**  **A fused and isolated electrical supply of the appropriate phase, frequency and voltage should be installed.**

The electrical power and control panel is wired to the latest European standards and codes of practice.

Mains supply is 3 phase and a neutral is not required. Refer to *Interconnecting Wiring*, on page 62.

### OPTIONAL EXTRAS – ENERGY SAVING

#### Power Factor Correction

When applied to the motors of each compressor, the compressor power factor is controlled to a minimum operating value of 0.95 at the full operating capacity. This satisfies many supply authorities that may impose surcharges on equipment with power factor less than 0.95.

### OPTIONAL EXTRAS – GENERAL

#### Corrosion Resistant Coated Coils

In atmospheres where high corrosion is anticipated a corrosion resistant coating is applied to the aluminium fins of either phenolic or epoxy, dependent upon size.

#### Coil Guards

Guards can be fitted to each of the outer coils to protect against damage.

## General Description

### OPTIONAL EXTRAS – GENERAL

<b>Anti Vibration Mounts</b> (Spring Type)	<p>Spring vibration isolators can be supplied loose for on site fitting to the base frame of each chiller unit.</p> <p>The isolators are suitable for fitting to structural steelwork providing the surface is level and of sufficient strength where a high level of vibration elimination is required.</p> <p>For further details, please refer to <i>Anti vibration mounting (optional)</i>, on page 59.</p>
<b>Anti Vibration Mounts</b> (Pad Type)	<p>Pad vibration isolators can be supplied loose for on site fitting to the base frame of each chiller unit.</p> <p>The isolators are suitable for fitting to structural steelwork providing the surface is level and of sufficient strength where a moderate degree of vibration elimination is required.</p> <p>For further details, please refer to <i>Anti vibration mounting (optional)</i>, on page 59.</p>
<b>Chiller Sequence Manager</b>	<p>For the efficient temperature and capacity operation of multiple units on a single site, the sequence manager will permit interlinked operation of the complete system thereby providing optimum temperature control and minimum power consumption.</p> <p>Upto 8 units can be sequenced.</p> <p>Included within this package is a site visit by Airedale Control Specialists to set up multiple unit sequence control.</p> <p>The chiller sequence manager is supplied as a separate control panel to be mounted remotely indoors, such as a plant room.</p>
<b>BMS Interface Card</b>	<p>Enables <b>AIRE</b>Tronix controlled chillers to be interfaced with most BMS, including Airedale's own pCOWeb, factory fitted, please contact Airedale.</p>
<b>Single Pressure Relief Valve</b> UCFC75 – UCC160	<p>A shut-off valve incorporating a relief valve and rupture disc assembly is provided per circuit. The valve allows the maintenance of individual pressure relief valves and rupture discs without the need for refrigerant evacuation.</p>
<b>Maintainable Dual Pressure Relief Valve</b> UCFC180 – UCFC450	<p>A 3-way dual shut-off valve that incorporates 2 relief valves and rupture disc assemblies per circuit. The valve allows the maintenance of individual pressure relief valves and rupture discs without the need for refrigerant evacuation.</p>
<b>Electronic Soft Start</b>	<p>The electronic soft start enables the chiller compressor motor to be ramped to speed with the minimum full load current. Further benefits include removal of nuisance tripping, supply voltage dips and motor overheating.</p>
<b>R407C Leak Detection System</b>	<p>A factory calibrated and fitted leak detection system, will raise an alarm when refrigerant gas is detected.</p> <p>Fitted within the unit compressor enclosure.</p>
<b>Extended Discharge Air Plenum - Condenser Fan</b>	<p>Constructed from galvanised sheet steel coated with epoxy baked powder paint, this plenum directs discharge air vertically, thus limiting greatly air re-circulation and provides a degree of acoustic reduction in the horizontal plane; factory fitted. For details please contact Airedale.</p> <p>Standard unit colour is Light Grey (RAL 7035).</p> <p>For further details refer to <i>Dimension Data</i>, on page 53.</p>

## General Description

### OPTIONAL EXTRAS – GENERAL

<b>Evaporator Differential Pressure Sensor</b>	Facilitates low flow limiting and pressure drop monitoring via the microprocessor.
<b>Control Panel Low Ambient Protection</b>	Supplementary heating can be offered to the control panel to ensure components such as LCD displays operate in low ambients conditions.
<b>Remote Setpoint Adjust</b>	Allows the chilled water setpoint to be adjusted via an external 0-10V signal.
<b>Flushing Bypass Kit (Standard)</b>	<p>Comprises:</p> <ul style="list-style-type: none"> <li>• Shut off valves</li> </ul> <p>Factory fitted to protect the evaporator from clogging by sediment and to enable the system to be purged before running.</p>
<b>Flushing Bypass Kit (Regulating)</b>	<p>Comprises:</p> <ul style="list-style-type: none"> <li>• Shut off valves</li> <li>• Double regulating valve</li> </ul> <p>Factory fitted to protect the evaporator from clogging by sediment and to enable the system to be purged before running.</p> <p>The regulating Flushing Bypass Kit additionally allows the chiller to run with a lower <math>\Delta T</math> (typically for chilled beam and/or high water temperature applications).</p>
<b>Internal Pumps Packages</b>	<p>In line pumps may be fitted, <b>standard or larger sizes</b> selected to suit installed system requirements. The following configurations are available:</p> <p><b>Single Head Pump</b>                      Factory fitted with electrical switchgear and isolating valve.</p> <p><b>Twin Head Pump</b>                      Factory fitted with common inlet and outlet connections and twin motor and pump impellers. Featuring automatic changeover via a paddle switch, electrical switchgear and isolating valve.</p> <p><b>Single Head Run/Standby Pumps</b>      Factory fitted Dual pumps with shut off valves on the inlet and outlet and non-return valves on the outlet in automatic changeover configuration. Supplied with electrical switchgear and isolating valve.</p> <p style="margin-left: 40px;">The microprocessor can be programmed to automatically rotate usage of the run/standby pumps to a set period.</p>
<b>Alternative Refrigerant</b>	For applications outside the EU, units can be supplied for use with R22, please specify at time of order.
<b>Commissioning</b>	Airedale Service provides a full commissioning service carried out by professionally trained, industry experienced engineers. For a competitive quotation, please contact Airedale Customer Services.
<b>Chillerguard® UK Mainland</b>	In addition to commissioning, a 24 hour, 7 days a week on-call service is available throughout the year to UK mainland sites. This service will enable customers to contact a duty engineer outside normal working hours and receive assistance over the telephone. The duty engineer can, if necessary, attend site, usually within 24 hours or less. Full details will be forwarded on acceptance of the maintenance agreement.

## Design Features & Information

**CAUTION**  All free cooling units should use minimum 20% glycol concentration.

### FREE COOLING

The Ultima Compact FreeCool chiller has been designed to provide the cooling load required whilst optimising energy efficiency **at all times** and as such will take advantage of free cooling whenever available. If the free cooling available cannot satisfy the required full cooling load, direct expansion cooling is used to supplement the output as shown below:

- 1 Water Inlet
- 2 Water Outlet

### FREE COOLING OPERATION

In high ambients where free cooling is not available the fan speed modulates in the conventional manner to maintain a constant head pressure. Free cooling is initiated wherever the outdoor ambient is 1°C less than the return water temperature.

When free cooling and DX mechanical cooling are operating simultaneously the condenser fan speed will operate at 100% maximising free cooling.

In ambients where the free cooling coil is capable of satisfying the full cooling demand, the condenser fans are modulated to provide the desired duty. The condenser fans are capable of being modulated between 25-100% of airflow to maintain the supply water temperature.

During periods where the condenser fan speed has been reduced to a minimum, the supply water temperature will then be controlled by the 3 way valve.

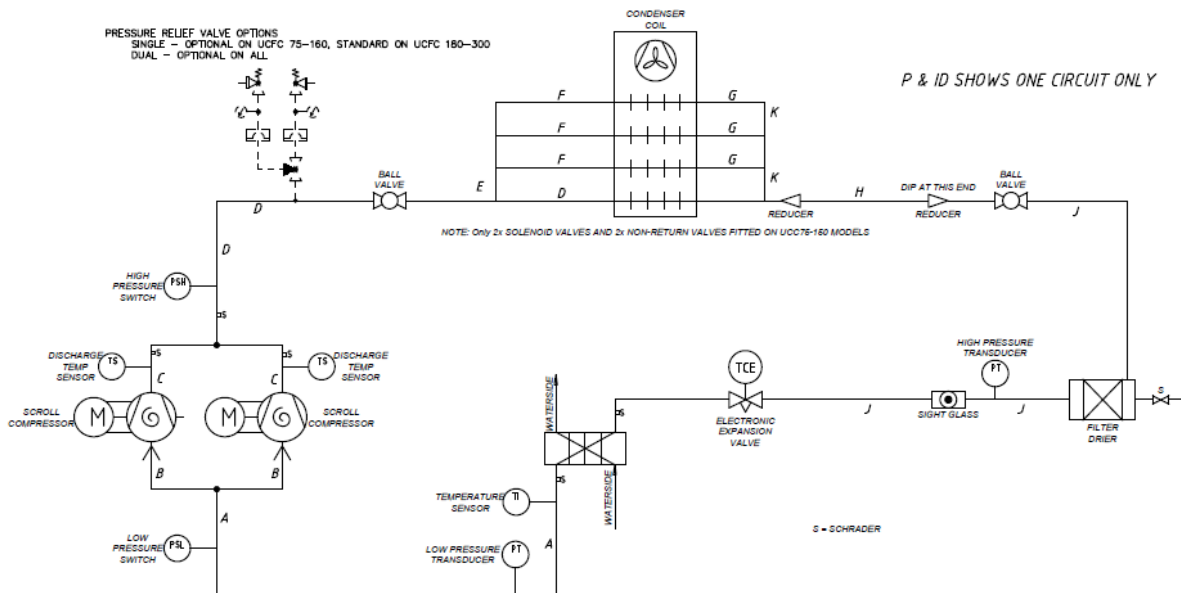

## Design Features & Information

### ELECTRONIC EXPANSION VALVES (EEV)

Using an EEV allows for good refrigeration control whilst operating at part load and lower ambient conditions with a reduced condensing pressure. By fitting an EEV and adjusting the head pressure control setting **an increase in the system EER (Energy Efficiency Ratio) of up to 30% can typically be seen.** The Mollier diagram shown below helps to illustrate how this increase in efficiency is achieved.

EEV's differ to normal thermostatic expansion valves in their ability to maintain control of refrigerant flow and the suction superheat at reduced head pressures. The turn-down rate of a typical EEV is superior to that of its thermostatic equivalent, such that a reduced optimum condensing pressure can be maintained at low compressor load. However low the load is on the compressor, from zero to 100%, there will not be a problem with turn down, even down to 30% of the valves rated capacity.

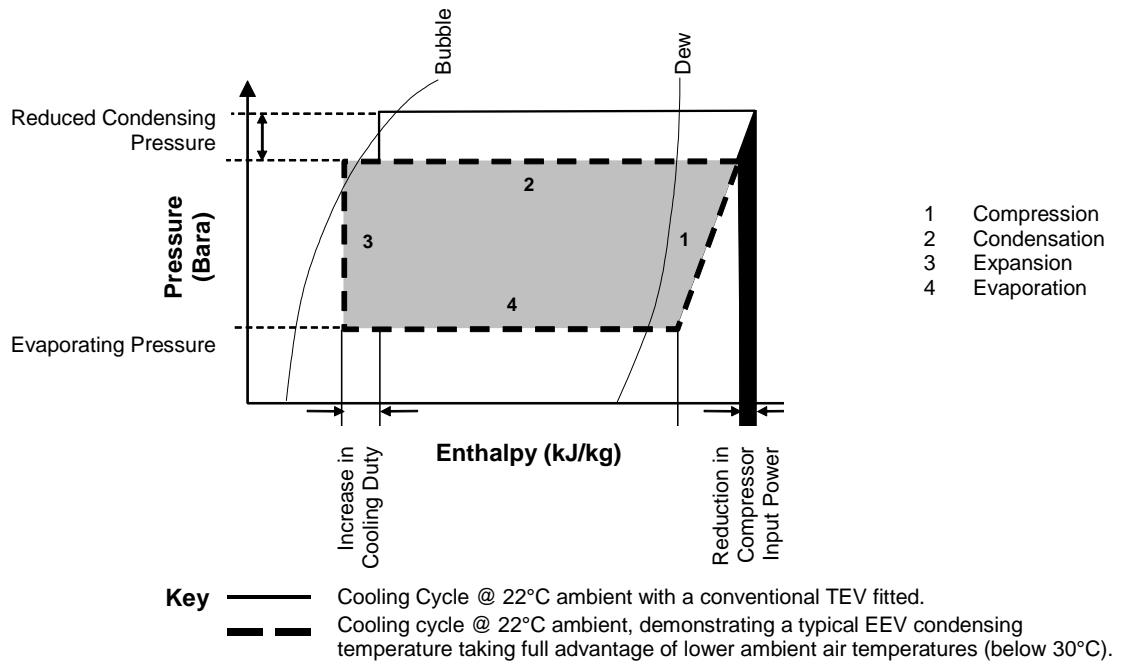

## Design Features & Information

### MINIMUM SYSTEM WATER VOLUME CALCULATIONS (DX Mechanical Cooling Mode Requirements)

#### GENERAL

Based on 20% Ethylene Glycol Concentration

**METHOD 1** Where the system permanent heat load is known:

$$V_m = \frac{\text{Water Flow Rate (litres/minute)} \times \text{Minimum Compressor Run Time (mins)}}{\text{Chiller Loading Factor}}$$

Where  $V_m$  is the minimum water volume in litres  
Minimum Compressor Run Time is 2 minutes

$$\text{Chiller Loading Factor} = \frac{\text{Minimum Turndown (kW)} \times 1.2}{\text{Permanent Heat Load}}$$

The Chiller Loading Factor limits:

Max 1.00

Min 0.25

**Example 150 kW Chiller, 7/12°C Water, Model UCFC150D-3/1 with a permanent load of 60 kW**

$$V_m = \frac{150 \times 60}{3.9 \times 5} \times 2 \times \frac{40 \times 1.2}{60} = 738 \text{ Litres}$$

**METHOD 2** Where the system permanent heat load is unknown:

$$V_m = \frac{\text{Water Flow Rate (litres/hour)} \times \text{Minimum Turndown Ratio} \times 1.2}{\text{Maximum Compressor Starts Per Hour}}$$

Where Minimum Turndown Ratio =  $\frac{\text{Minimum Stage Capacity (kW)}}{\text{Chiller Full Capacity (kW)}}$

**Example 150 kW Chiller, 7/12°C Water, Model UCFC150D-3/1 permanent load unknown.**

$$V_m = \frac{150 \times 3600}{3.9 \times 5} \times \left( \frac{1}{4} \times 1.2 \right) \times \frac{1}{12} = 692 \text{ Litres}$$

 **Method 1 is always preferred.**



## AIRETronix Controls

### GENERAL DESCRIPTION

The microprocessor controller offers powerful analogue and digital control to meet a wide range of monitoring and control features including a real time clock and Industry standard communication port and network connections.

The controller's inbuilt display is used for viewing the unit operating status and making adjustments to control parameters by allowing the operator access to a series of display pages.

Also featured are a visual alarm and the facility to adjust and display control settings by local operator for information and control.

### DISPLAY/KEYPAD

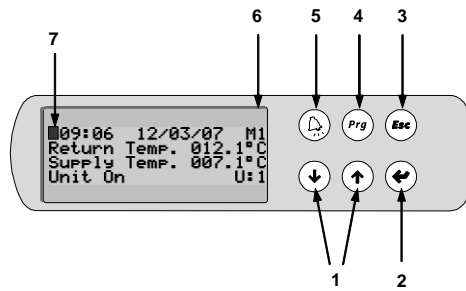

- 1 UP/DOWN KEYS - To change Adjustable Fields & Scrolls up & down available Menus
- 2 ENTER -Selects Menus & Moves Cursor to Adjustable Fields Green LED
- 3 ESC - Green LED lit when Operating Page displayed, Returns to Operating Page Screen when pressed
- 4 PROGRAM - Opens the Available Menus
- 5 ALARM - Red LED Indicates Alarm Present
- 6 4 ROW LCD DISPLAY
- 7 CURSOR (FLASHING) Top Left Position = "HOME" Indicates adjustable Fields

## AIRETRONIX Controls

### TEMPERATURE CONTROL

Airedale recognises that all chiller applications are different but fall mainly into 2 application categories; Variable Supply Temperature and Constant Supply Temperature.

The onboard microprocessor has the capability of satisfying either control requirement as illustrated below. Using the Airedale Variable Supply Temperature control scheme, energy savings are available when compared with previous schemes and that of the Constant Supply Temperature application.

Variable Supply Temperature control schemes offer energy savings where the supply water temperature is not critical to its operation and is recommended for free cooling applications.

Selection of the best application control scheme can be made via a soft switch in the microprocessor during initial commissioning.

The microprocessor maintains the set supply Chilled Water temperature by sensing the return and supply water temperatures and ambient air temperature to adjust the compressor loading and water valve position as required.

#### Examples based on Models UCFC125D-3/1 having 6 Stages of Cooling

- Key:**
- 1 Return Water Temperature
  - 2 Mean Value
  - 3 Supply Water Temperature
  - 4 Compressor Off

#### Variable Supply Temperature Control

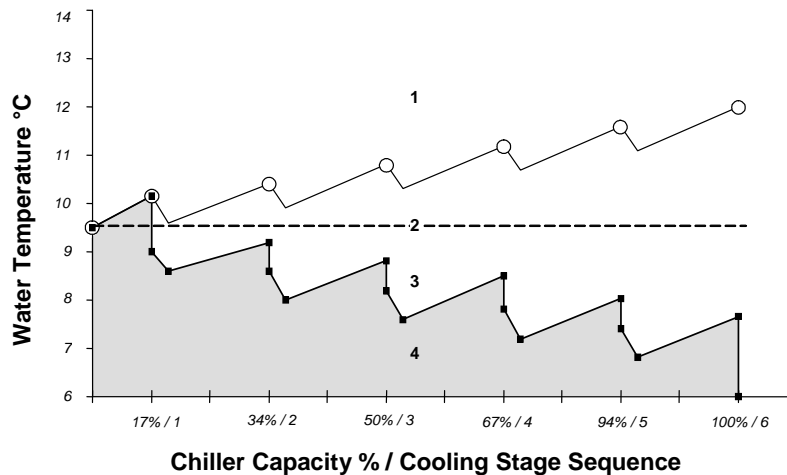

#### Constant Supply Temperature Control

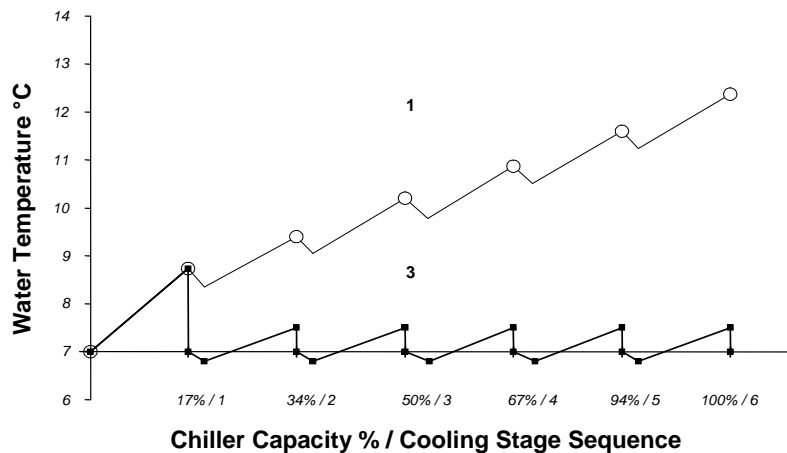

**CAUTION** Factory set to Variable Supply Temperature Control unless otherwise stated at order.

Only when the mode selection has been set can the unit be enabled.

---

**AIRETronix Controls****MONITORING**

The microprocessor also monitors and displays the following measured parameters:

- Supply Water Temperature
- Return Water Temperature
- Evaporator Inlet water temperature
- Ambient Air Temperature
- Suction Pressure of each circuit
- Liquid Pressure of each circuit
- Suction Temperature at each circuit
- Superheat for each circuit

**ALARM HANDLING**

The controller logs and allows viewing of the last 100 conditions recorded in descending chronological order through the keypad display.

The following conditions will be detected, triggering a visual display:

**Common for both circuits:**

- Low Supply Temperature
- Mains Phase Failure / Phase Rotation
- Emergency Stop
- Water Flow
- Pump(s) status
- Pump(s) remote start

**Individual for each circuit:**

Individual alarms will isolate the affected circuit only.

- Compressor Trip
- Low Suction Pressure for each circuit
- High Liquid Pressure for each circuit
- Volt Free Contact Alarm Indication
- Low Pressure Switch
- Compressor Overload
- Isolator Status
- High Compressor Discharge Temperature

**NETWORKING**

A Local Area Network (**AIRELar**) can be used to connect a number of chiller controllers to offer intercommunication and sequence control. There is also the facility to allow the connection of either a computer or modem for local or remote monitoring. For further details, please contact Airedale.

**CAUTION**

**When adding to an existing network, please consult Airedale to ensure strategy compatibility.**



## Performance Data

### CAPACITY DATA – DX MECHANICAL COOLING

#### Standard - D Models

Leaving Water Temperature °C	Air on Coil								
	20°C		25°C		30°C		35°C		
	Output kW	Input kW	Output kW	Input kW	Output kW	Input kW	Output kW	Input kW	
UCFC75D-2/1	5	76.4	20.2	72.5	22.7	68.6	25.3	64.5	28.0
	6	78.9	20.4	75.0	23.0	70.9	25.6	66.8	28.3
	7	81.5	20.7	77.5	23.2	73.4	25.8	69.1	28.5
	10	89.6	21.4	85.3	23.9	80.9	26.5	76.3	29.2
UCFC100D-2/1	5	95.7	29.7	90.6	33.1	85.4	36.7	80.1	40.3
	6	98.8	30.1	93.6	33.5	88.3	37.0	82.9	40.6
	7	102.0	30.5	96.7	33.9	91.2	37.4	85.7	41.0
	10	111.7	31.7	106.1	35.1	100.3	38.5	94.4	42.1
UCFC125D-3/1	5	127.7	34.5	121.2	38.7	114.5	43.2	107.4	48.0
	6	131.9	34.9	125.2	39.1	118.3	43.6	111.1	48.4
	7	136.1	35.3	129.3	39.5	122.3	44.0	114.8	48.9
	10	149.1	36.5	141.9	40.8	134.3	45.4	126.3	50.5
UCFC150D-3/1	5	149.1	44.8	141.2	50.0	132.9	55.7	123.8	62.2
	6	153.9	45.2	145.8	50.5	137.2	56.5	127.8	63.1
	7	158.8	45.7	150.5	51.1	141.5	57.2	131.7	64.2
	10	173.7	46.9	164.6	52.9	154.5	60.1	143.1	68.6
UCFC160D-6/2	5	165.3	42.4	157.2	45.1	149.3	47.7	141.3	50.4
	6	170.7	42.6	162.5	45.3	154.3	47.9	146.1	50.6
	7	176.1	42.8	167.7	45.5	159.3	48.1	150.9	50.8
	10	192.9	43.5	183.9	46.1	175.0	48.7	166.1	51.4
UCFC180D-6/2	5	185.9	43.7	176.9	49.1	168.0	54.5	159.0	59.9
	6	192.1	44.3	182.8	49.7	173.6	55.0	164.4	60.4
	7	198.1	44.8	188.6	50.2	179.2	55.6	169.8	61.0
	10	216.8	46.6	206.6	51.9	196.6	57.2	186.5	62.6
UCFC200D-6/2	5	205.3	50.9	195.7	57.2	186.4	63.5	177.0	69.8
	6	211.9	51.6	202.1	58.0	192.5	64.2	182.9	70.4
	7	218.4	52.4	208.4	58.7	198.6	64.9	188.7	71.1
	10	238.6	54.6	227.9	60.9	217.5	67.0	207.0	73.2
UCFC225D-6/2	5	233.0	59.8	222.2	66.7	211.6	73.5	200.9	80.4
	6	240.5	60.7	229.4	67.6	218.5	74.4	207.5	81.2
	7	247.9	61.6	236.6	68.5	225.4	75.3	214.2	82.1
	10	270.8	64.4	258.7	71.3	246.8	78.0	234.8	84.7
UCFC250D-8/2	5	264.6	62.3	252.8	70.2	241.2	78.0	229.5	85.9
	6	273.0	63.2	260.9	71.1	249.0	78.9	237.0	86.8
	7	281.5	64.2	269.1	72.1	256.9	79.9	244.6	87.7
	10	307.6	67.1	294.3	75.0	281.3	82.8	268.2	90.6
UCFC275D-8/2	5	288.9	74.1	275.5	82.5	262.3	90.6	249.1	98.9
	6	297.9	75.3	284.1	83.6	270.6	91.7	257.0	99.9
	7	306.9	76.4	292.8	84.7	279.0	92.8	265.1	101.0
	10	334.5	79.9	319.5	88.1	304.8	96.1	290.0	104.2
UCFC300D-8/2	5	317.6	84.2	302.4	93.0	287.4	101.6	272.4	110.3
	6	327.3	85.5	311.7	94.2	296.4	102.8	281.0	111.4
	7	336.9	86.8	321.0	95.5	305.3	104.0	289.6	112.6
	10	366.6	90.6	349.7	99.2	333.1	107.6	316.4	116.1
UCFC330D-10/2	5	353.0	88.8	336.5	99.2	320.4	109.4	304.1	119.7
	6	364.3	90.1	347.5	100.5	330.9	110.7	314.2	121.0
	7	375.7	91.4	358.4	101.8	341.4	112.0	324.3	122.3
	10	410.6	95.5	392.2	105.8	374.0	116.0	355.8	126.2
UCFC360D-10/2	5	377.6	99.7	360.9	111.4	344.4	123.0	327.8	134.7
	6	389.6	101.2	372.4	113.0	355.5	124.6	338.6	136.2
	7	401.6	102.8	384.0	114.6	366.7	126.1	349.4	137.7
	10	438.4	107.7	419.6	119.4	401.2	130.9	382.7	142.4
UCFC400D-12/2	5	426.8	110.8	407.2	123.3	388.0	135.6	368.8	148.0
	6	440.2	112.5	420.1	125.0	400.4	137.2	380.6	149.5
	7	453.5	114.2	432.9	126.6	412.8	138.9	392.6	151.1
	10	494.3	119.4	472.4	131.7	451.0	143.8	429.5	155.9
UCFC450D-12/2	5	473.9	126.2	451.3	139.4	429.1	152.3	406.8	165.3
	6	488.4	128.1	465.2	141.2	442.5	154.1	419.6	167.0
	7	502.9	130.0	479.1	143.1	455.9	155.8	432.5	168.7
	10	547.1	135.8	521.9	148.7	497.2	161.3	472.5	173.9

1 Output based on 20% Ethylene Glycol concentration. For alternative concentrations, refer to **Glycol Data**, on page 32.

2 Unit water/glycol flow rate (l/s) =  $\frac{\text{Output kW}}{\Delta T \times C_p \text{ (Water/20\% Glycol)}}$  =  $\frac{\text{Output kW}}{\Delta T \times 3.9}$

3 For operation outside the shaded area, please refer to Airedale.

## Performance Data

### CAPACITY DATA – DX MECHANICAL COOLING

#### Quiet – DQ Models

Leaving Water Temperature °C	Air on Coil								
	20°C		25°C		30°C		35°C		
	Output kW	Input kW	Output kW	Input kW	Output kW	Input kW	Output kW	Input kW	
UCFC75DQ-2/1	5	74.2	21.6	70.4	24.1	66.4	26.8	62.4	29.5
	6	76.7	21.9	72.7	24.4	68.7	27.0	64.6	29.7
	7	79.2	22.2	75.2	24.7	71.0	27.3	66.8	30.0
	10	86.8	23.0	82.6	25.5	78.2	28.2	73.6	30.9
UCFC100DQ-3/1	5	100.5	26.5	95.2	30.0	89.9	33.6	84.5	37.3
	6	103.8	26.8	98.4	30.3	93.0	33.9	87.5	37.6
	7	107.2	27.1	101.7	30.7	96.2	34.2	90.5	37.8
	10	117.6	28.2	111.8	31.6	106.0	35.1	100.0	38.7
UCFC125DQ-3/1	5	123.8	37.0	117.2	41.4	110.4	45.9	103.2	50.8
	6	127.8	37.5	121.0	41.9	114.0	46.5	106.7	51.4
	7	131.8	38.0	124.9	42.4	117.7	47.0	110.2	52.0
	10	144.1	39.4	136.8	43.9	129.1	48.8	120.9	54.0
UCFC150DQ-4/1	5	152.8	42.3	145.1	47.3	136.9	52.9	128.2	59.1
	6	157.8	42.8	150.0	47.8	141.5	53.5	132.4	59.8
	7	162.9	43.2	154.8	48.3	146.1	54.1	136.7	60.7
	10	178.3	44.0	169.7	49.4	160.1	56.1	149.3	63.9
UCFC160DQ-6/2	5	160.2	37.3	152.1	42.1	144.1	46.8	136.0	51.6
	6	165.3	37.8	157.0	42.5	148.8	47.2	140.6	52.0
	7	170.4	38.2	161.9	43.0	153.6	47.7	145.1	52.4
	10	186.2	39.7	177.2	44.4	168.3	49.0	159.4	53.6
UCFC180DQ-6/2	5	180.3	47.1	171.4	52.5	162.6	57.7	153.8	63.0
	6	186.1	47.7	177.0	53.1	168.0	58.3	159.0	63.6
	7	191.8	48.4	182.5	53.7	173.3	58.9	164.1	64.2
	10	209.5	50.4	199.6	55.6	189.8	60.8	180.0	66.0
UCFC200DQ-6/2	5	201.1	53.7	191.7	59.9	182.5	66.1	173.2	72.3
	6	207.5	54.5	197.8	60.7	188.4	66.9	178.9	73.0
	7	213.8	55.3	203.9	61.5	194.2	67.6	184.5	73.8
	10	233.3	57.7	222.8	63.9	212.5	70.0	202.2	76.0
UCFC225DQ-8/2	5	234.2	59.1	223.3	66.0	212.7	72.8	201.9	79.7
	6	241.7	60.0	230.5	66.9	219.6	73.7	208.6	80.5
	7	249.2	60.9	237.8	67.8	226.6	74.6	215.3	81.4
	10	272.2	63.6	260.0	70.5	248.1	77.2	236.1	84.0
UCFC250DQ-8/2	5	259.7	65.6	248.0	73.4	236.5	81.1	225.0	88.9
	6	267.8	66.6	255.8	74.4	244.1	82.1	232.3	89.8
	7	276.0	67.6	263.7	75.5	251.7	83.2	239.6	90.8
	10	301.3	70.9	288.2	78.7	275.4	86.3	262.6	93.9
UCFC275DQ-10/2	5	290.5	73.2	276.9	81.6	263.7	89.8	250.3	98.1
	6	299.5	74.3	285.6	82.7	272.0	90.9	258.3	99.1
	7	308.6	75.4	294.4	83.7	280.4	91.9	266.4	100.2
	10	336.4	78.8	321.3	87.1	306.5	95.2	291.6	103.4
UCFC300DQ-10/2	5	315.6	85.4	300.4	94.2	285.5	102.8	270.5	111.4
	6	325.2	86.7	309.6	95.4	294.3	104.0	278.9	112.6
	7	334.8	88.0	318.8	96.6	303.2	105.2	287.5	113.7
	10	364.1	91.9	347.2	100.4	330.6	108.9	314.0	117.3
UCFC330DQ-12/2	5	352.3	89.2	335.9	99.6	319.8	109.8	303.6	120.1
	6	363.6	90.6	346.7	100.9	330.2	111.1	313.6	121.4
	7	374.9	91.9	357.6	102.3	340.7	112.4	323.7	122.6
	10	409.6	96.1	391.2	106.4	373.1	116.5	355.0	126.6
UCFC360DQ-12/2	5	376.8	100.3	360.1	112.0	343.7	123.6	327.2	135.1
	6	388.7	101.9	371.5	113.6	354.7	125.1	337.9	136.7
	7	400.6	103.5	383.1	115.2	365.8	126.7	348.6	138.2
	10	437.1	108.5	418.4	120.1	400.1	131.5	381.8	142.9
UCFC400DQ-14/2	5	428.5	109.7	408.9	122.3	389.7	134.6	370.4	147.0
	6	441.9	111.4	421.8	123.9	402.1	136.2	382.3	148.5
	7	455.3	113.1	434.7	125.6	414.5	137.8	394.3	150.1
	10	496.3	118.3	474.3	130.6	452.8	142.8	431.4	154.9
UCFC450DQ-14/2	5	470.1	128.4	447.6	141.5	425.6	154.3	403.5	167.2
	6	484.4	130.4	461.3	143.4	438.7	156.2	416.2	168.9
	7	498.6	132.4	475.0	145.3	451.9	158.0	428.9	170.7
	10	542.1	138.4	517.1	151.1	492.6	163.6	468.3	176.0

1 Output based on 20% Ethylene Glycol concentration. For alternative concentrations, refer to **Glycol Data**, on page 32.

2 Unit water/glycol flow rate (l/s) =  $\frac{\text{Output kW}}{\Delta T \times C_p (\text{Water}/20\% \text{ Glycol})}$  =  $\frac{\text{Output kW}}{\Delta T \times 3.9}$

3 For operation outside the shaded area, please refer to Airedale.

## Performance Data

### CAPACITY DATA – DX MECHANICAL COOLING

#### Super Quiet – DSQ Models

Leaving Water Temperature °C	Air on Coil								
	20°C		25°C		30°C		35°C		
	Output kW	Input kW	Output kW	Input kW	Output kW	Input kW	Output kW	Input kW	
UCFC75DSQ-2/1	5	69.4	24.8	65.6	27.3	61.7	29.9	57.7	32.6
	6	71.6	25.1	67.7	27.7	63.7	30.3	59.6	33.0
	7	73.9	25.5	69.9	28.0	65.8	30.7	61.6	33.4
	10	80.7	26.6	76.5	29.1	72.1	31.8	67.6	34.5
UCFC100DSQ-3/1	5	94.6	30.4	89.5	33.9	84.2	37.4	78.9	41.1
	6	97.7	30.9	92.4	34.3	87.1	37.8	81.6	41.4
	7	100.7	31.3	95.4	34.7	90.0	38.2	84.4	41.8
	10	110.3	32.6	104.6	35.9	98.8	39.4	92.9	43.0
UCFC125DSQ-4/1	5	123.4	37.3	116.8	41.6	110.1	46.1	103.0	51.0
	6	127.4	37.8	120.6	42.1	113.7	46.7	106.4	51.6
	7	131.4	38.3	124.5	42.6	117.4	47.2	109.9	52.2
	10	143.6	39.7	136.2	44.2	128.6	49.0	120.6	54.3
UCFC150DSQ-4/1	5	142.9	48.9	134.7	54.4	126.2	60.5	116.9	67.2
	6	147.4	49.5	138.9	55.3	130.0	61.5	120.4	68.5
	7	151.9	50.2	143.1	56.1	133.9	62.7	123.8	70.0
	10	165.5	52.3	155.6	59.3	144.9	67.2	132.9	76.5
UCFC160DSQ-8/2	5	159.9	44.1	152.0	46.8	144.2	49.4	136.4	52.0
	6	165.0	44.4	156.9	47.0	149.0	49.6	140.9	52.2
	7	170.1	44.7	161.9	47.3	153.8	49.9	145.6	52.5
	10	186.1	45.5	177.3	48.1	168.6	50.6	159.9	53.2
UCFC180DSQ-8/2	5	180.9	46.7	172.0	52.1	163.2	57.4	154.3	62.7
	6	186.8	47.4	177.6	52.7	168.6	58.0	159.5	63.3
	7	192.5	48.0	183.1	53.4	173.9	58.6	164.6	63.9
	10	210.3	50.0	200.3	55.3	190.4	60.5	180.6	65.7
UCFC200DSQ-8/2	5	201.8	53.2	192.3	59.5	183.1	65.7	173.7	71.9
	6	208.2	54.0	198.5	60.3	189.0	66.5	179.4	72.7
	7	214.5	54.8	204.6	61.1	194.9	67.2	185.1	73.4
	10	234.0	57.3	223.5	63.5	213.2	69.6	202.8	75.7
UCFC225DSQ-10/2	5	232.3	60.3	221.5	67.2	210.8	74.0	200.1	80.9
	6	239.8	61.2	228.6	68.1	217.7	74.9	206.6	81.8
	7	247.2	62.1	235.7	69.0	224.5	75.8	213.2	82.6
	10	269.9	64.9	257.7	71.8	245.7	78.6	233.7	85.3
UCFC250DSQ-10/2	5	257.6	66.9	245.9	74.8	234.4	82.5	222.9	90.3
	6	265.7	68.0	253.7	75.9	241.9	83.6	230.0	91.3
	7	273.8	69.1	261.5	76.9	249.4	84.6	237.3	92.3
	10	298.7	72.4	285.6	80.2	272.8	87.9	260.0	95.5
UCFC275DSQ-12/2	5	289.6	73.7	276.1	82.1	262.8	90.3	249.5	98.6
	6	298.5	74.9	284.7	83.2	271.1	91.4	257.4	99.7
	7	307.5	76.0	293.3	84.4	279.4	92.5	265.5	100.7
	10	335.1	79.5	320.0	87.8	305.3	95.9	290.4	104.0
UCFC300DSQ-12/2	5	314.4	86.1	299.2	94.9	284.3	103.4	269.4	112.1
	6	323.8	87.4	308.3	96.1	293.1	104.7	277.8	113.2
	7	333.3	88.7	317.4	97.4	301.8	105.9	286.2	114.4
	10	362.4	92.8	345.6	101.3	329.0	109.7	312.5	118.0
UCFC330DSQ-16/2	5	352.6	89.0	336.2	99.4	320.2	109.6	304.1	119.8
	6	363.8	90.4	347.0	100.8	330.5	110.9	314.1	121.1
	7	375.1	91.8	357.9	102.1	341.0	112.3	324.1	122.4
	10	409.6	96.1	391.3	106.3	373.3	116.4	355.4	126.4
UCFC360DSQ-16/2	5	376.9	100.1	360.2	111.9	343.9	123.4	327.6	134.8
	6	388.8	101.8	371.7	113.5	354.9	125.0	338.2	136.4
	7	400.7	103.5	383.1	115.2	366.0	126.6	348.9	138.0
	10	437.0	108.6	418.3	120.2	400.1	131.5	382.1	142.8
UCFC400DSQ-16/2	5	417.9	116.4	398.6	128.8	379.8	140.9	361.0	152.9
	6	430.7	118.3	411.0	130.6	391.6	142.6	372.4	154.6
	7	443.6	120.2	423.3	132.4	403.6	144.4	383.9	156.3
	10	482.7	125.9	461.3	138.0	440.3	149.8	419.5	161.5
UCFC450DSQ-16/2	5	456.7	136.2	434.7	149.0	413.1	161.6	391.8	174.0
	6	470.3	138.4	447.7	151.1	425.7	163.5	403.8	175.9
	7	483.8	140.5	460.7	153.2	438.2	165.5	416.0	177.7
	10	525.1	147.0	500.8	159.4	477.0	171.6	453.6	183.5

1 Output based on 20% Ethylene Glycol concentration. For alternative concentrations, refer to **Glycol Data**, on page 32.

2 Unit water/glycol flow rate (l/s) =  $\frac{\text{Output kW}}{\Delta T \times C_p \text{ (Water/20\% Glycol)}}$  =  $\frac{\text{Output kW}}{\Delta T \times 3.9}$

3 For operation outside the shaded area, please refer to Airedale.

## Performance Data

### CAPACITY DATA – FREE COOLING

Where  $\Delta T$  refers to the difference between Return Water and Ambient Temperatures eg:

$$\Delta T @ 12/7^{\circ}\text{C Water Temperature: } 5^{\circ}\text{C Ambient} = 7^{\circ}\text{C}$$

Example: UCFC150DSQ-4/1, water @ 10/15, 30°C Ambient, DX mechanical cooling 144.9kW  
(refer to *Capacity Data – DX Mechanical Cooling*, on page 21).

UCFC125DSQ-4/1  
UCFC150DSQ-4/1

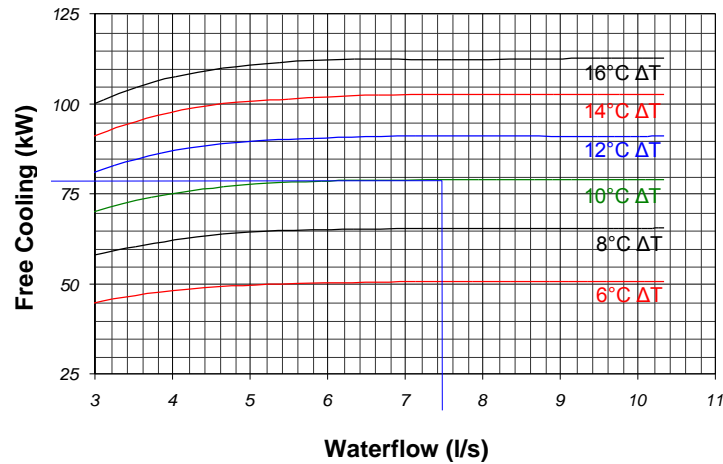

Flow =	$\frac{144.9}{5 \times 3.9} = 7.43 \text{ l/s}$
Free Cooling Duty @ 5°C Ambient:	
$\Delta T = \text{Return Water} - \text{Ambient}$	
	15°C
-	5°C
	<u>10°C ΔT</u>
Free Cooling Duty = <b>79kW</b>	



## Performance Data

### CAPACITY DATA – FREE COOLING

UCFC75D-2/1  
UCFC100D-2/1

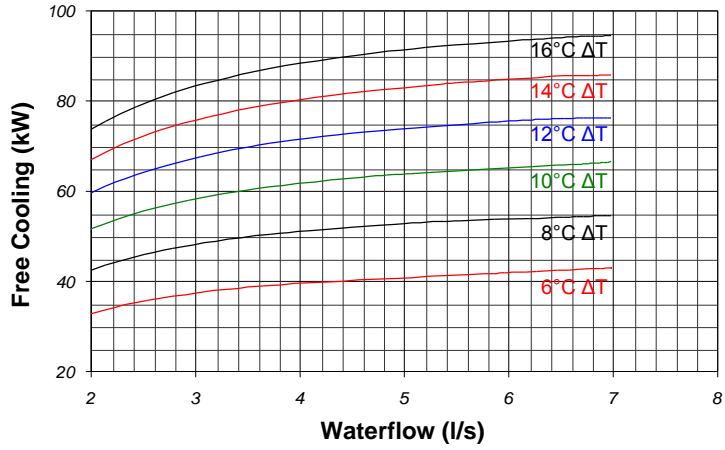

UCFC75DQ-2/1

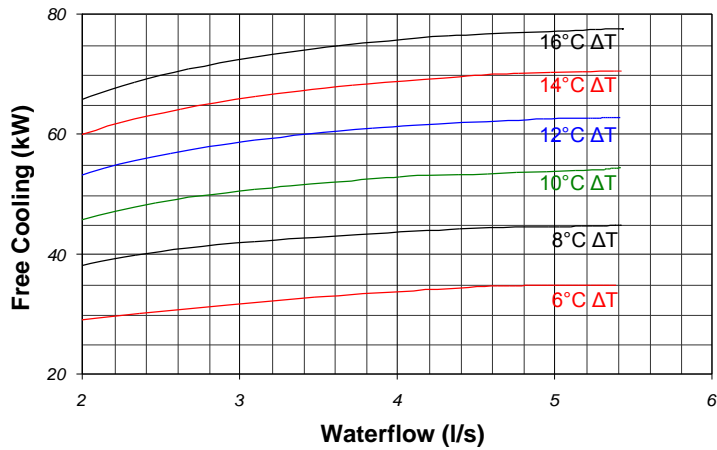

UCFC75DSQ-2/1

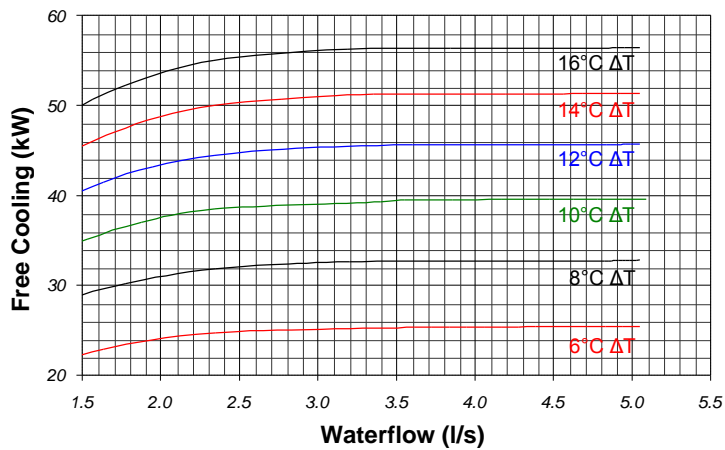

## Performance Data

### CAPACITY DATA – FREE COOLING

UCFC100DQ-3/1  
UCFC125DQ-3/1

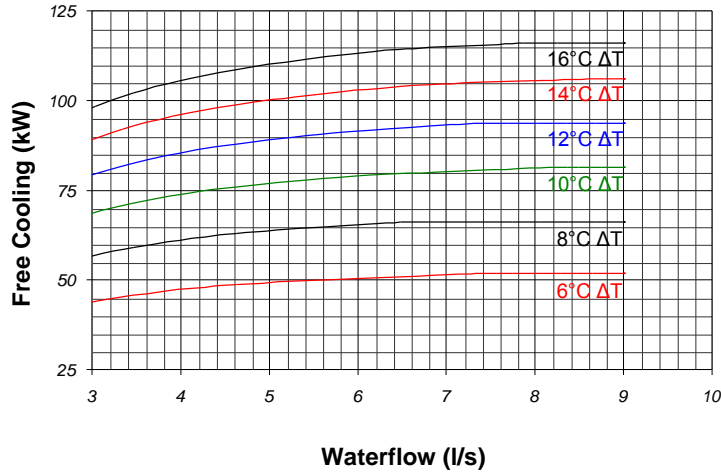

UCFC100DSQ-3/1

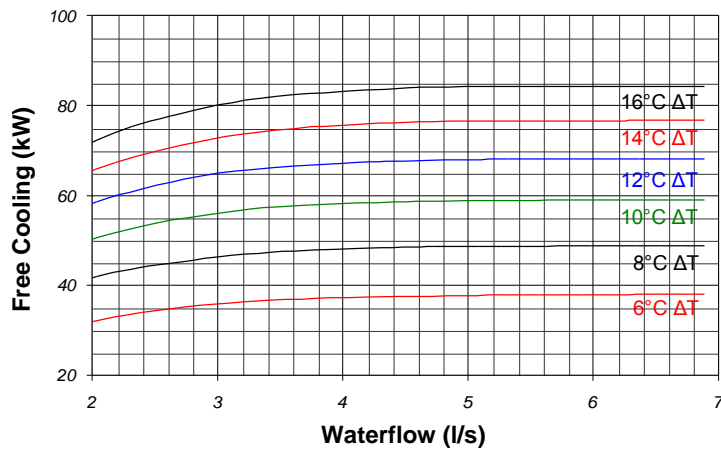

UCFC125D-3/1  
UCFC150D-3/1

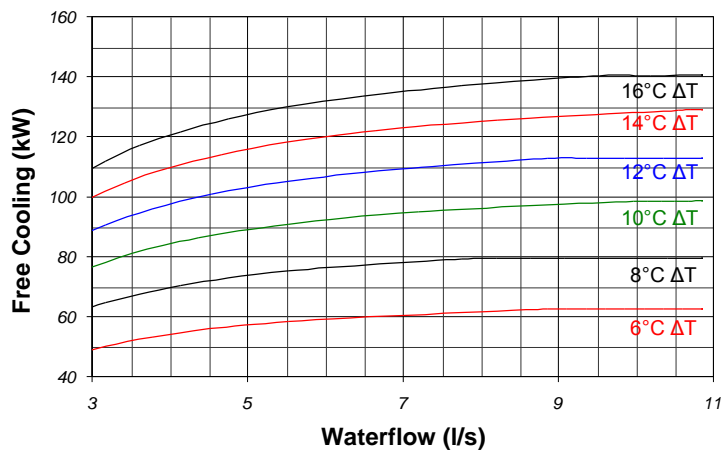

## Performance Data

### CAPACITY DATA – FREE COOLING

UCFC150DQ-4/1

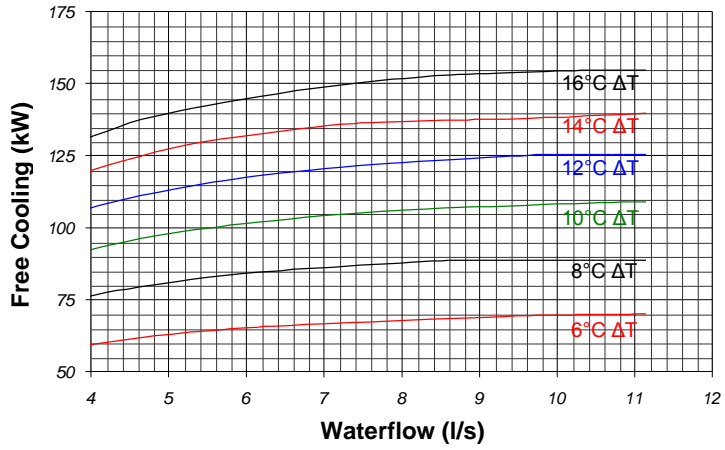

UCFC125DSQ-4/1  
UCFC150DSQ-4/1

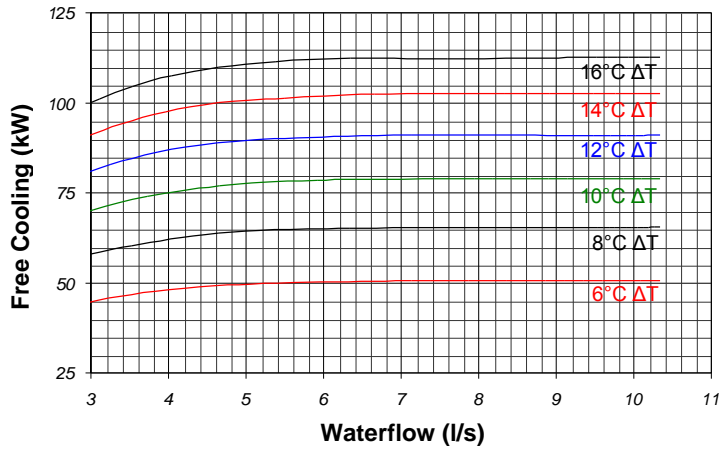

UCFC160D-6/2  
UCFC180D-6/2  
UCFC200D-6/2  
UCFC225D-6/2

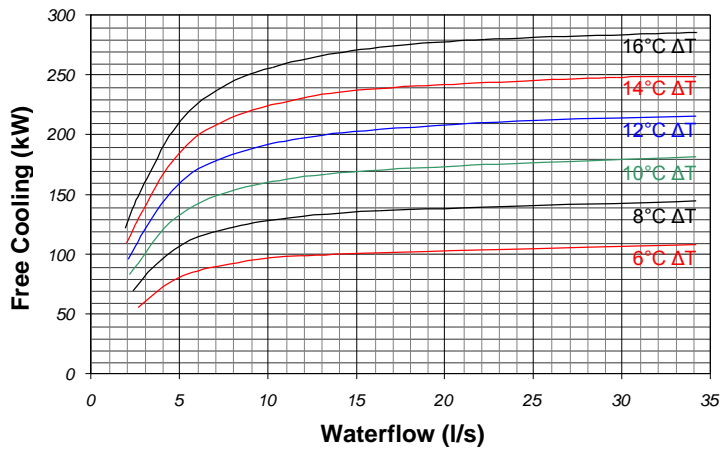

## Performance Data

### CAPACITY DATA – FREE COOLING

UCFC160DQ-6/2  
UCFC180DQ-6/2  
UCFC200DQ-6/2

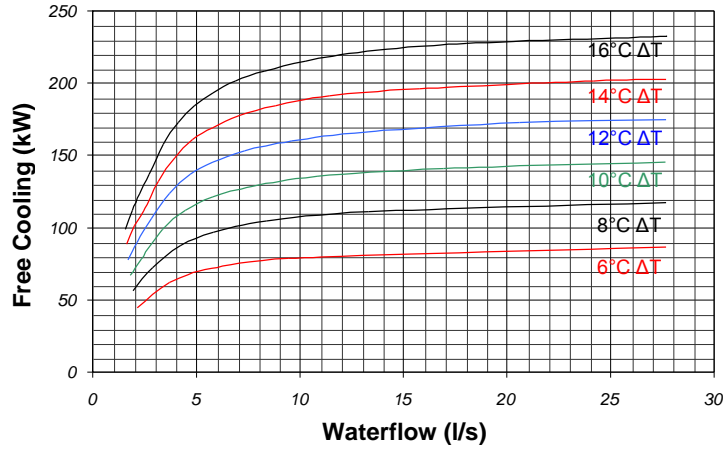

UCFC160DSQ-8/2  
UCFC180DSQ-8/2  
UCFC200DSQ-8/2

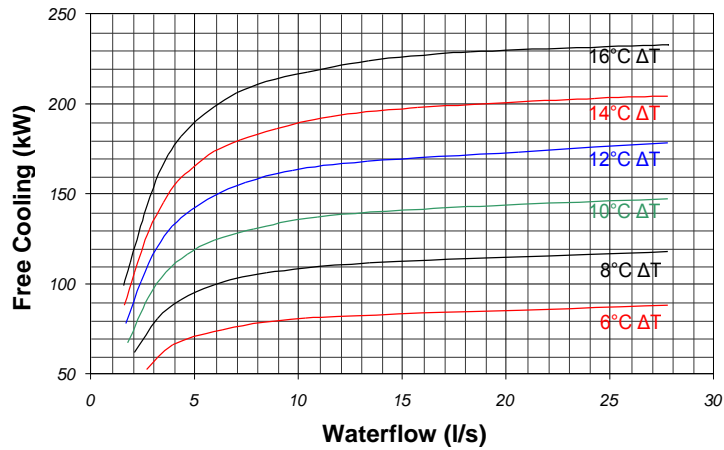

UCFC225DQ-8/2  
UCFC250DQ-8/2

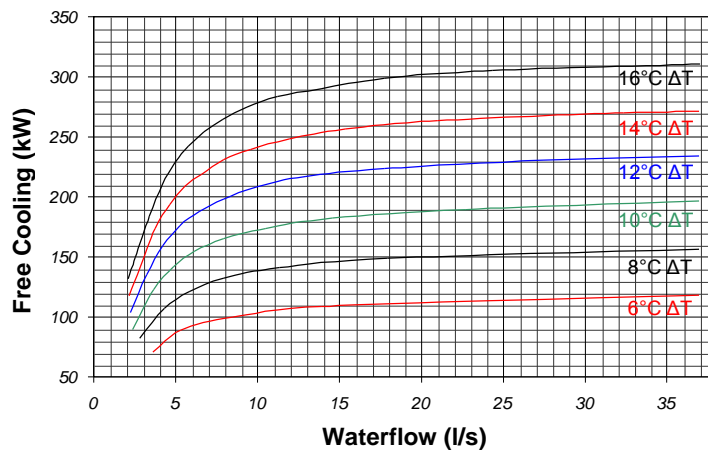

## Performance Data

### CAPACITY DATA – FREE COOLING

UCFC250D-8/2  
 UCFC275D-8/2  
 UCFC300D-8/2

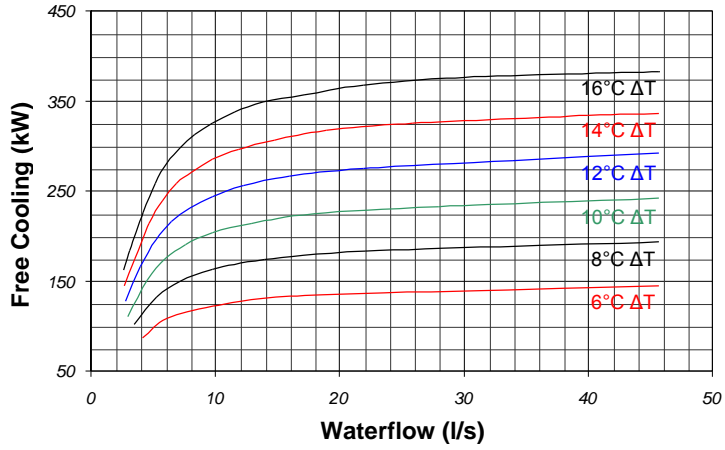

UCFC225DSQ-10/2  
 UCFC250DSQ-10/2

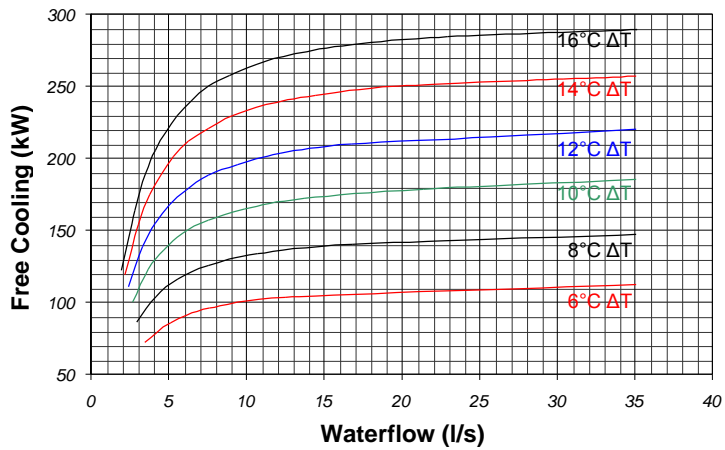

UCFC275DQ-10/2  
 UCFC300DQ-10/2

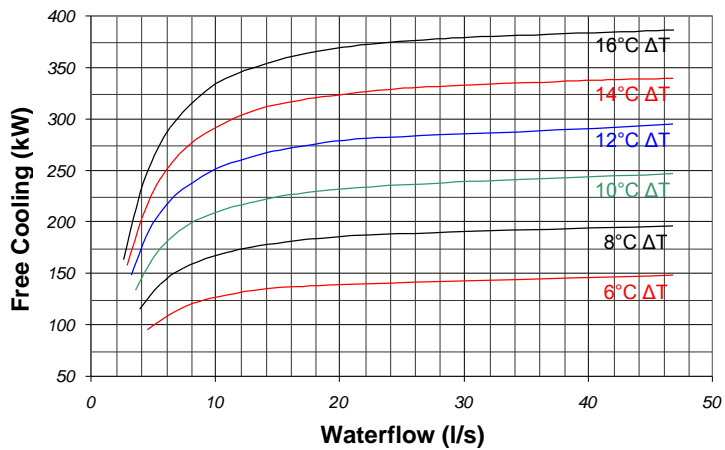

## Performance Data

### CAPACITY DATA – FREE COOLING

UCFC275DSQ-12/2  
UCFC300DSQ-12/2

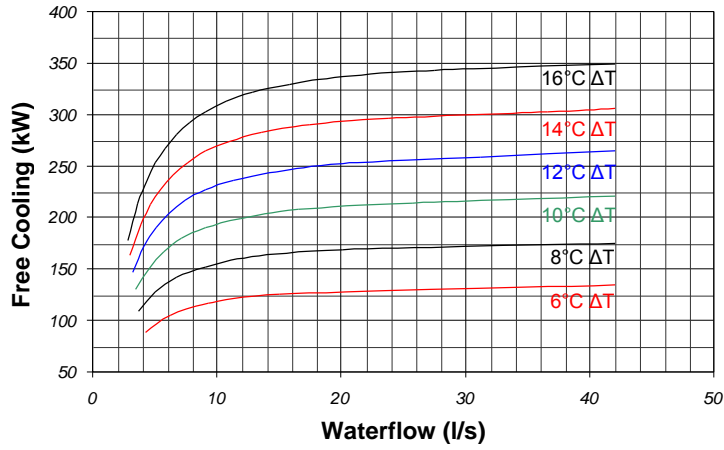

UCFC330D-10/2  
UCFC360D-10/2

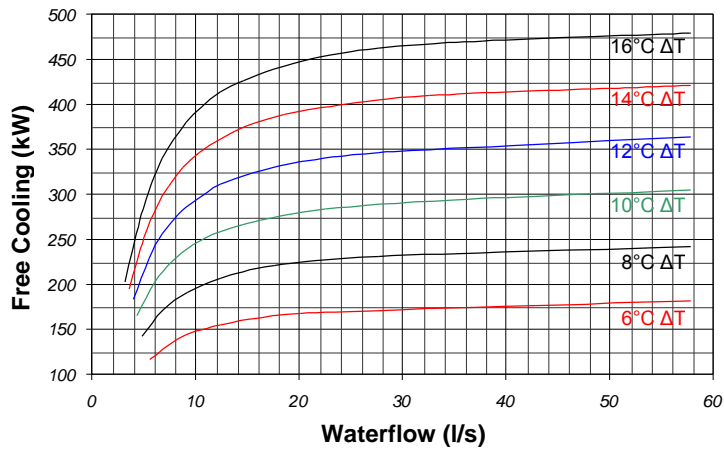

UCFC330DQ-12/2  
UCFC360DQ-12/2

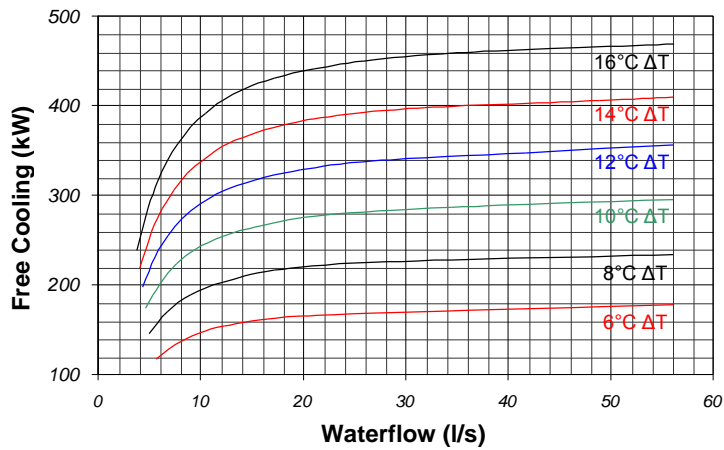

## Performance Data

### CAPACITY DATA – FREE COOLING

UCFC330DSQ-16/2  
 UCFC360DSQ-16/2  
 UCFC400DSQ-16/2  
 UCFC450DSQ-16/2

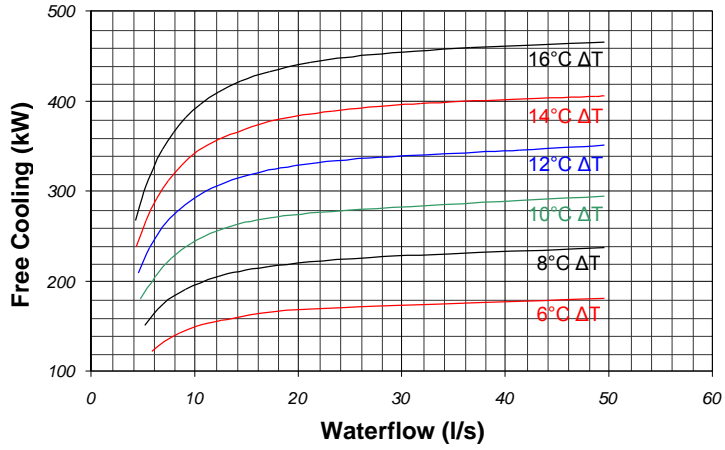

UCFC400D-12/2  
 UCFC450D-12/2

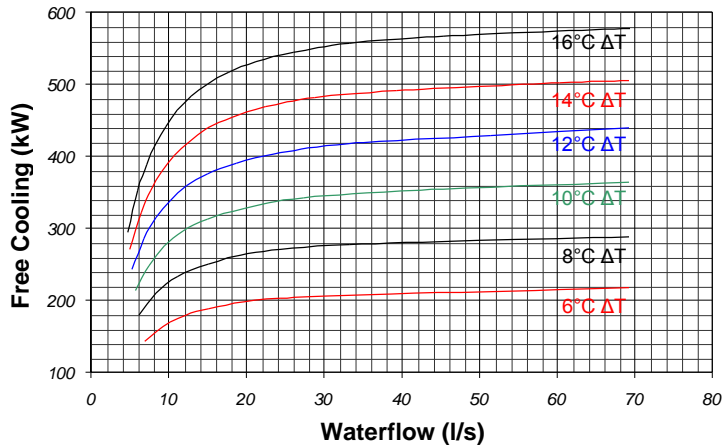

UCFC400DQ-14/2  
 UCFC450DQ-14/2

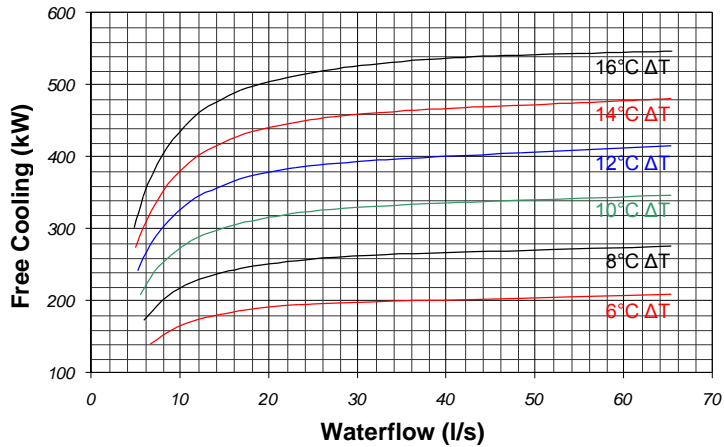

## Performance Data

### OPERATING LIMITS

Unit With Electronic Fan Speed HP Control (-20°C)	
Minimum Ambient air DB °C	-20°C
Maximum Ambient air DB °C	Refer to <b>Capacity Data – DX Mechanical Cooling</b> , on page 21
Minimum leaving water temperature °C	+5°C
Maximum return water temperature °C	+18°C

- 1 Temperatures lower than those stated can be obtained with additional glycol.
- 2 For conditions outside those quoted, please refer to Airedale.

### GLYCOL DATA

For a given percentage of glycol in the system there are correction factors that need to be applied, the following tables can be used as a guide.

**CAUTION**  All free cooling units should use minimum 20% glycol concentration.

### Ethylene Glycol Nominal Correction Factors

Glycol in System / Freezing Point °C	20% / -9°C	30% / -15°C	40% / -23°C
Cooling Duty	1.00	0.98	0.96
Input Power	1.00	0.98	0.97
Water Flow	1.00	1.09	1.12
Pressure Drop	1.00	1.29	1.48

Catalogue Data x by:

### Propylene Glycol Nominal Correction Factors

Glycol in System / Freezing Point °C	20% / -6°C	30% / -12°C	40% / -20°C
Cooling Duty	0.98	0.94	0.91
Input Power	1.00	0.98	0.97
Water Flow	1.00	0.99	0.99
Pressure Drop	1.08	1.22	1.35

Catalogue Data x by:

### Example UCFC150DQ-4/1 operating at 7/12, 30°C Ambient, 30% Ethylene Glycol

	Catalogue Figure	Multiplier	Corrected Figure
Cooling kW (refer to <b>Capacity Data – DX Mechanical Cooling</b> , on page 21)	146.1	x 0.98	143.2 kW
Input kW (refer to <b>Capacity Data – DX Mechanical Cooling</b> , on page 21)	54.1	x 0.98	53.0 kW
Flow l/s (calculated $\frac{\text{(DX Mechanical Cooling kW)}}{\Delta T \times 3.9}$ )	7.49	x 1.09	8.16 l/s
Pressure Drop kPa (refer to <b>Waterside Pressure Drops</b> , on page 33)	146	x 1.29	188 kPa

30% Ethylene Glycol =



## Performance Data

### WATERSIDE PRESSURE DROPS (20% Ethylene Glycol Concentration)

**CAUTION**  Full design water flow **MUST** be maintained at all times. Variable water volume is **NOT** recommended and will invalidate warranty.

Use the formula below to calculate the External Head Available:

$$\boxed{\text{Total Pump Head Available}} - \boxed{\text{Chiller Pressure Drop}} = \boxed{\text{External Head Available}}$$

Example: UCFC125D-3/1 6.12 l/s, standard single pump:

$$\boxed{265 \text{ kPa}} - \boxed{112 \text{ kPa}} = \boxed{153 \text{ kPa}}$$

### UCFC75 - UCFC125

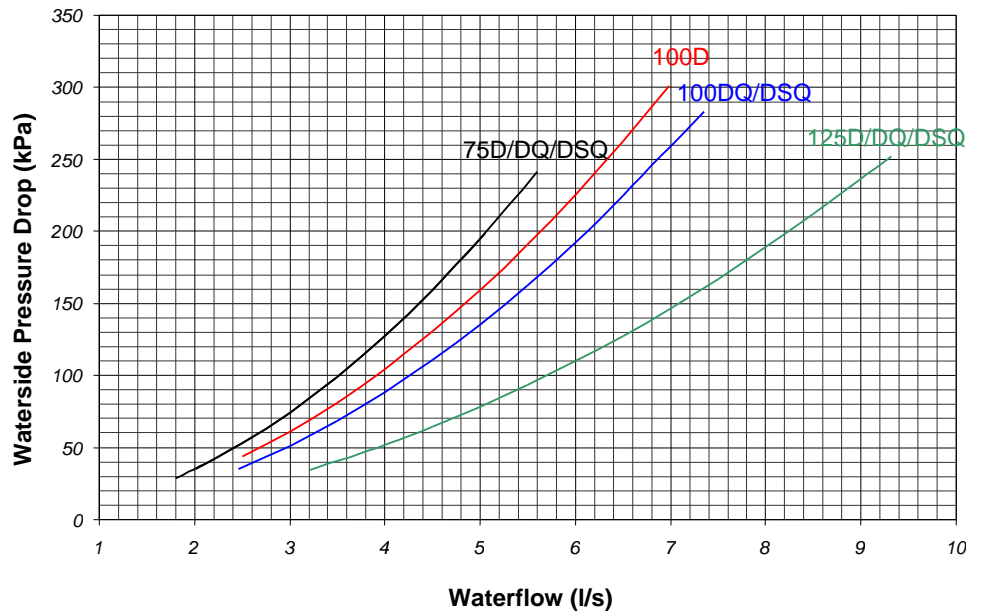

### UCFC150

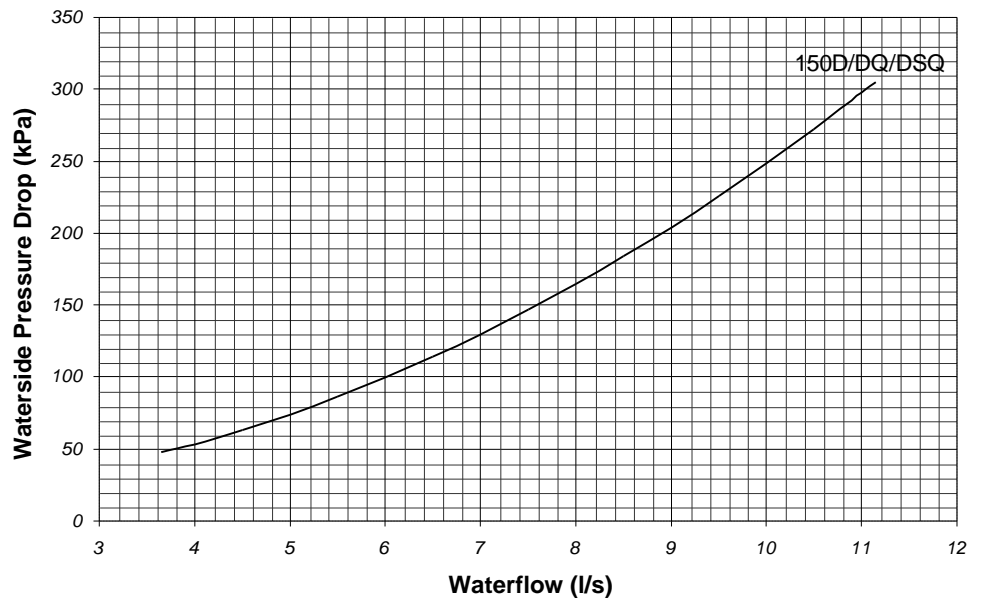

- 1 Chiller pressure drop refers to standard unit only. For pump options, please contact Airedale.
- 2 For glycol solutions, please refer to **Glycol Data**, on page 32.

## Performance Data

### WATERSIDE PRESSURE DROPS (20% Ethylene Glycol Concentration)

**CAUTION** ▽ Full design water flow **MUST** be maintained at all times. Variable water volume is **NOT** recommended and will invalidate warranty.

#### UCFC160D - UCFC450D



#### UCFC160DQ - UCFC450DQ

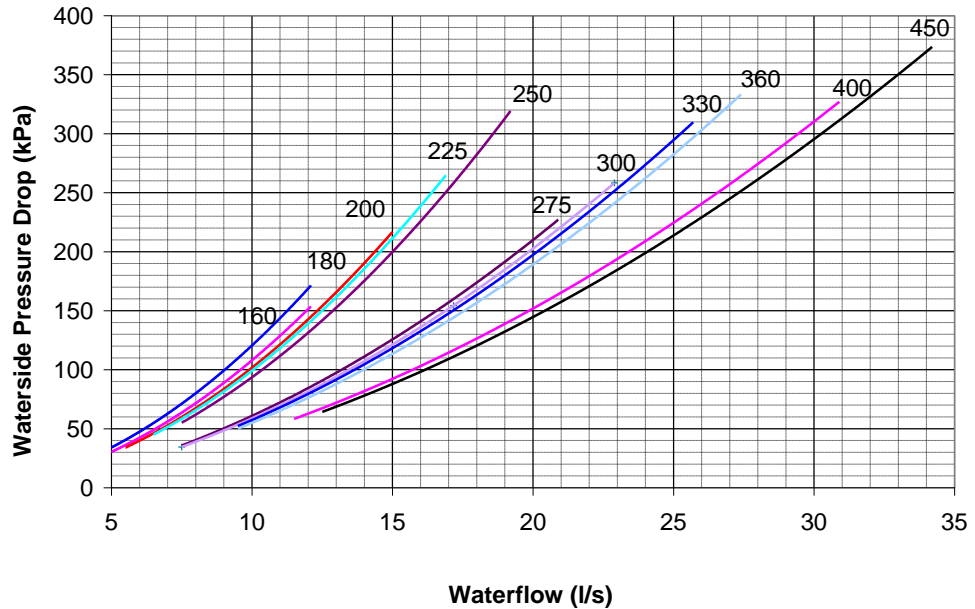

- 1 Chiller pressure drop refers to standard unit only. For pump options, please contact Airedale.
- 2 For glycol solutions, please refer to **Glycol Data**, on page 32.

## Performance Data

### WATERSIDE PRESSURE DROPS (20% Ethylene Glycol Concentration)

**CAUTION** ▼ Full design water flow **MUST** be maintained at all times. Variable water volume is **NOT** recommended and will invalidate warranty.

UCFC160DSQ -  
UCFC450DSQ

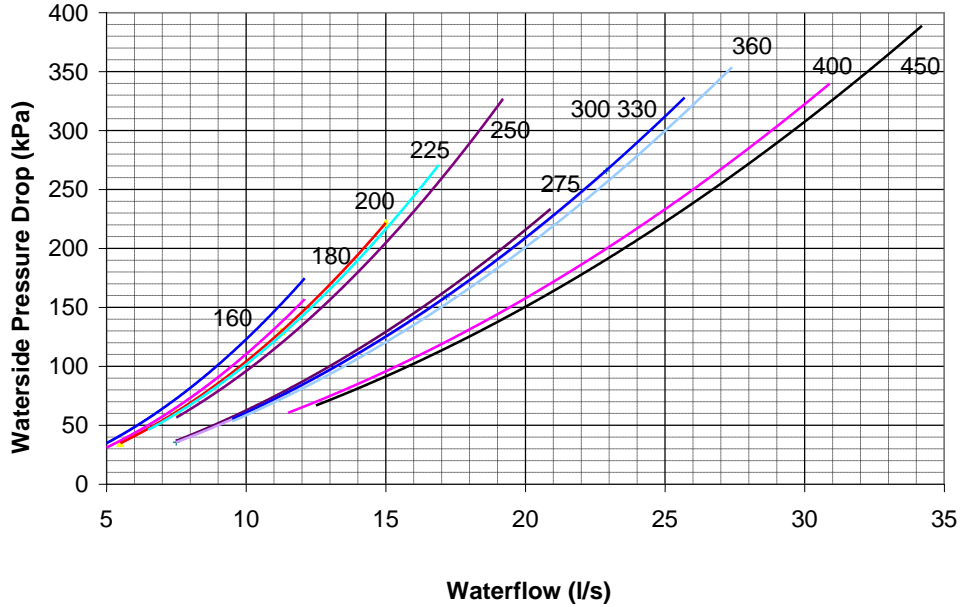

- 1 Chiller pressure drop refers to standard unit only. For pump options, please contact Airedale.
- 2 For glycol solutions, please refer to **Glycol Data**, on page 32.

## Performance Data

### PUMP PACKAGES

Single Head Pump or Run/Standby

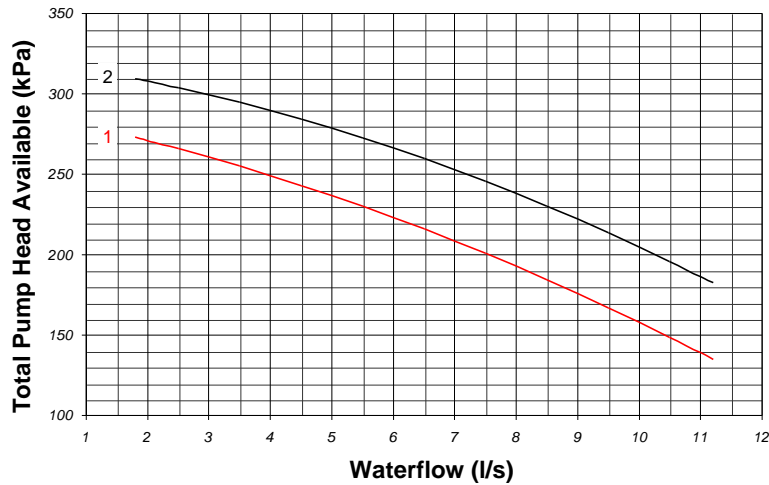
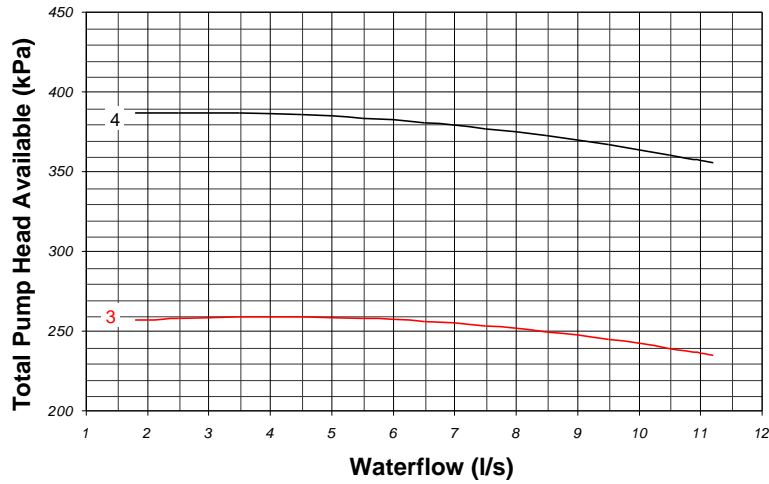
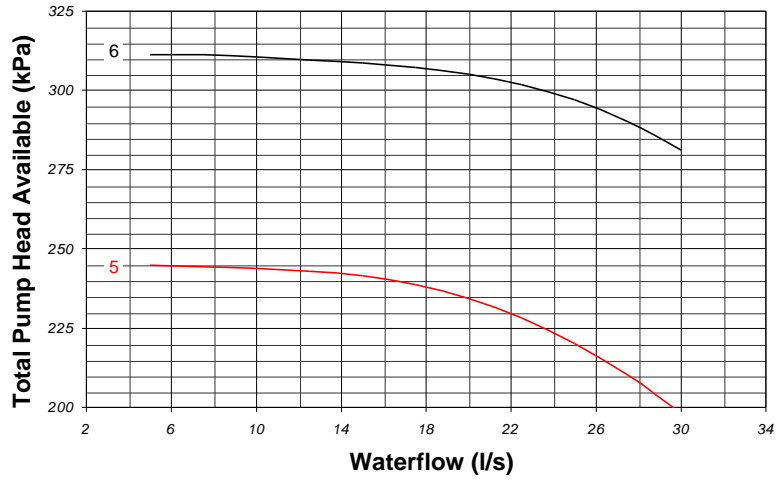

	Single Head Pump or Run / Standby Pump	
	Standard	Larger
UCFC75	1	2
UCFC100	1	2
UCFC125	2	4
UCFC150	3	4
UCFC160 - UCFC450	5	6

## Performance Data

### PUMP PACKAGES

#### Twin Head Pump

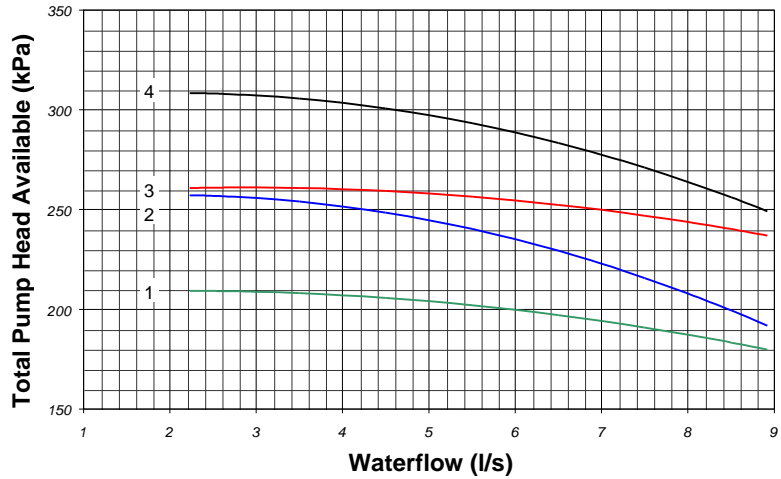
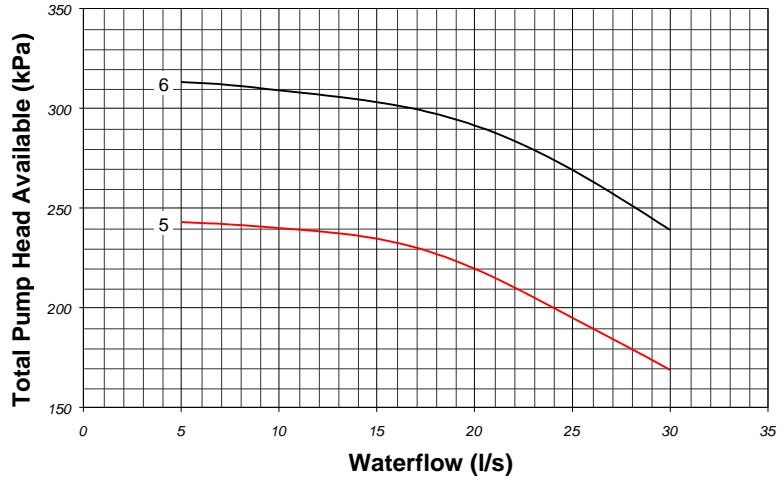

	Twin Head Pump	
	Standard	Larger
UCFC75	1	2
UCFC100	1	3
UCFC125	1	3
UCFC150	2	4
UCFC160 - UCFC450	5	6

## Sound Data

### MEASUREMENT OF SOUND DATA

All sound data quoted has been measured in the third-octave band limited values, using a Real Time Analyser calibrated sound intensity meter in accordance with BS EN ISO9614 Part 1: 2009. The Global sound data quoted is valid for noise emitted in the horizontal plane in all directions.

All Sound Power Levels quoted are calculated from measured sound intensity according to BS EN ISO9614 Part 1: 2009.

Sound Pressure Levels are calculated from sound power using the expanded parallelepiped method according to BS EN ISO11203: 2009.

### SOUND DIRECTIVITY

The **Global** sound measurements quoted in the following tables **do not** incorporate any directivity or denote any sound level heard at any given position surrounding the chiller, rather they represent the total sound level radiating from the chiller in **all directions in the horizontal plane** from source.

Using the adjustment factors from the map below, specific directional sound power levels can be derived from the global sound power data.

**Example – UCFC150DSQ-4/1, Sound Power of 78dB(A) =**

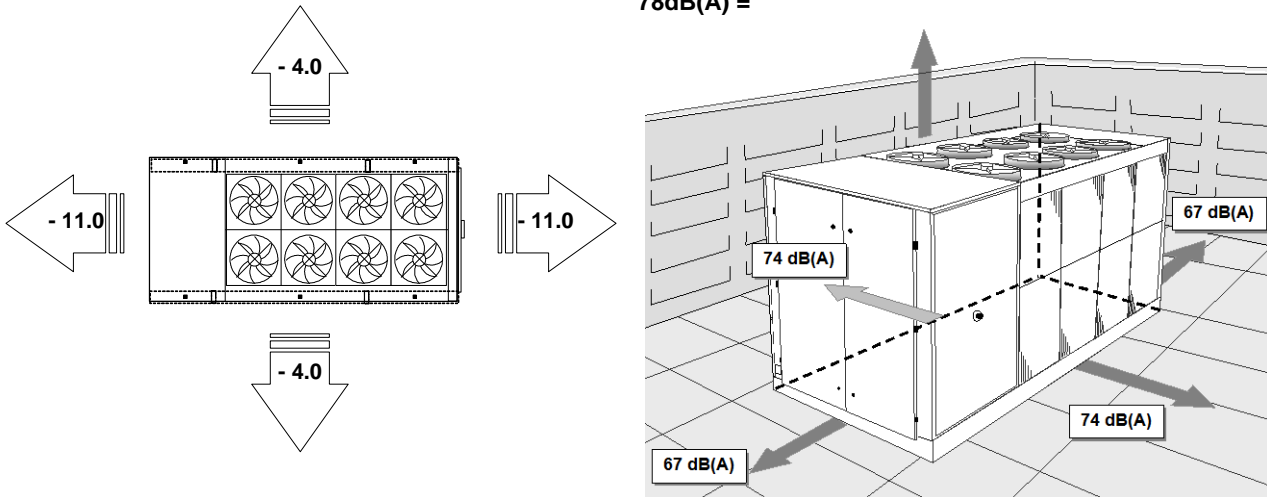

## Sound Data

### GLOBAL & DIRECTIONAL SOUND LEVEL

#### Standard - D Models

Model	Sound Measurement	Overall dB(A)	Frequency (Hz) dB						
			63	125	250	500	1000	2000	4000
UCFC75D-2/1	Power	81	74	80	77	79	78	72	63
	Pressure @ 10m	49	42	48	45	47	46	40	31
UCFC100D-2/1	Power	81	80	84	78	79	78	72	63
	Pressure @ 10m	49	48	52	46	47	46	40	31
UCFC125D-3/1	Power	84	74	84	83	81	80	74	65
	Pressure @ 10m	52	42	52	51	49	48	42	33
UCFC150D-3/1	Power	84	74	84	83	81	80	74	65
	Pressure @ 10m	52	42	52	51	49	48	42	33
UCFC160D-6/2	Power	87	72	84	82	85	83	78	70
	Pressure @ 10m	55	40	52	50	53	51	46	38
UCFC180D-6/2	Power	87	75	84	82	85	83	78	71
	Pressure @ 10m	55	43	52	50	53	51	46	39
UCFC200D-6/2	Power	87	73	84	82	86	83	78	70
	Pressure @ 10m	55	41	52	50	54	51	46	38
UCFC225D-6/2	Power	88	75	84	82	86	84	78	71
	Pressure @ 10m	56	43	52	50	54	52	46	39
UCFC250D-8/2	Power	89	74	85	83	87	85	79	71
	Pressure @ 10m	57	42	53	51	55	53	47	39
UCFC275D-8/2	Power	89	76	85	83	87	85	80	73
	Pressure @ 10m	57	44	53	51	55	53	48	41
UCFC300D-8/2	Power	89	78	85	83	88	85	81	75
	Pressure @ 10m	57	46	53	51	56	53	49	43
UCFC330D-10/2	Power	90	77	86	84	88	86	80	73
	Pressure @ 10m	58	45	54	52	56	54	48	41
UCFC360D-10/2	Power	90	75	86	84	89	86	80	73
	Pressure @ 10m	58	43	54	52	57	54	48	41
UCFC400D-12/2	Power	91	78	87	85	89	87	82	75
	Pressure @ 10m	59	46	55	53	57	55	50	43
UCFC450D-14/2	Power	91	80	87	85	89	87	83	77
	Pressure @ 10m	59	48	55	53	57	55	51	45

#### Quiet - DQ Models

Model	Sound Measurement	Overall dB(A)	Frequency (Hz) dB						
			63	125	250	500	1000	2000	4000
UCFC75DQ-2/1	Power	77	75	80	73	75	74	68	61
	Pressure @ 10m	45	43	48	41	43	42	36	29
UCFC100DQ-3/1	Power	79	81	85	75	77	75	70	63
	Pressure @ 10m	47	49	53	43	45	43	38	31
UCFC125DQ-3/1	Power	80	75	84	82	77	76	70	64
	Pressure @ 10m	48	43	52	50	45	44	38	32
UCFC150DQ-4/1	Power	81	76	85	82	79	77	71	65
	Pressure @ 10m	49	44	53	50	47	45	39	33
UCFC160DQ-6/2	Power	83	76	84	77	81	79	74	68
	Pressure @ 10m	51	44	52	45	49	47	42	36
UCFC180DQ-6/2	Power	83	76	84	77	82	79	74	68
	Pressure @ 10m	51	44	52	45	50	47	42	36
UCFC200DQ-6/2	Power	84	76	84	77	82	79	74	68
	Pressure @ 10m	52	44	52	45	50	47	42	36
UCFC225DQ-8/2	Power	85	78	85	78	84	80	75	69
	Pressure @ 10m	53	46	53	46	52	48	43	37
UCFC250DQ-8/2	Power	85	77	85	78	84	81	75	69
	Pressure @ 10m	53	45	53	46	52	49	43	37
UCFC275DQ-10/2	Power	86	79	86	79	85	81	77	71
	Pressure @ 10m	54	47	54	47	53	49	45	39
UCFC300DQ-10/2	Power	86	79	86	79	85	82	78	72
	Pressure @ 10m	54	47	54	47	53	50	46	40
UCFC330DQ-12/2	Power	86	79	87	80	85	82	77	71
	Pressure @ 10m	54	47	55	48	53	50	45	39
UCFC360DQ-12/2	Power	87	79	87	80	86	82	77	71
	Pressure @ 10m	55	47	55	48	54	50	45	39
UCFC400DQ-14/2	Power	87	80	88	81	86	83	79	73
	Pressure @ 10m	54	47	55	48	53	50	46	40
UCFC450DQ-14/2	Power	88	81	88	81	86	83	80	74
	Pressure @ 10m	55	48	55	48	53	50	47	41

1 dB(A) is the overall sound level, measured on the A scale.

2 All sound data measured at nominal conditions: Water in/out 12/7°C at 30°C ambient.

3 Figures based on standard unit, for units fitted with optional pump packages, please contact Airedale.



The Sound Pressure data quoted is only valid in free field conditions, where the unit is installed on a reflective base. If the equipment is placed adjacent to a reflective wall, values may vary to those stated, typically increasing by 3dB for each side added.

## Sound Data

### GLOBAL & DIRECTIONAL SOUND LEVEL

#### Super Quiet - DSQ Models

Sound Measurement	Overall dB(A)	Frequency (Hz) dB						
		63	125	250	500	1000	2000	4000
UCFC75DSQ-2/1 Power Pressure @ 10m	73	76	80	76	67	68	62	53
	41	44	48	44	35	36	30	21
UCFC100DSQ-3/1 Power Pressure @ 10m	75	81	84	78	69	70	64	56
	43	49	52	46	37	38	32	24
UCFC125DSQ-4/1 Power Pressure @ 10m	78	77	85	83	72	71	66	58
	46	45	53	51	40	39	34	26
UCFC150DSQ-4/1 Power Pressure @ 10m	78	77	85	83	72	71	66	58
	46	45	53	51	40	39	34	26
UCFC160DSQ-8/2 Power Pressure @ 10m	80	79	85	82	77	75	72	64
	48	47	53	50	45	43	40	32
UCFC180DSQ-8/2 Power Pressure @ 10m	81	79	85	82	78	76	72	65
	49	47	53	50	46	44	40	33
UCFC200DSQ-8/2 Power Pressure @ 10m	81	79	85	82	80	76	72	65
	49	47	53	50	48	44	40	33
UCFC225DSQ-10/2 Power Pressure @ 10m	82	80	85	83	81	77	72	66
	50	48	53	51	49	45	40	34
UCFC250DSQ-10/2 Power Pressure @ 10m	83	80	85	83	82	77	72	66
	51	48	53	51	50	45	40	34
UCFC275DSQ-12/2 Power Pressure @ 10m	84	81	86	84	82	78	75	69
	52	49	54	52	50	46	43	37
UCFC300DSQ-12/2 Power Pressure @ 10m	84	81	86	84	82	78	76	71
	52	49	54	52	50	46	44	39
UCFC330DSQ-16/2 Power Pressure @ 10m	84	82	88	85	83	79	74	68
	51	49	55	52	50	46	41	35
UCFC360DSQ-16/2 Power Pressure @ 10m	84	82	88	85	83	79	74	67
	51	49	55	52	50	46	41	34
UCFC400DSQ-16/2 Power Pressure @ 10m	85	82	88	85	83	79	76	71
	52	49	55	52	50	46	43	38
UCFC450DSQ-16/2 Power Pressure @ 10m	86	82	88	85	84	80	78	72
	53	49	55	52	51	47	45	39

- 1 dB(A) is the overall sound level, measured on the A scale.
- 2 All sound data measured at nominal conditions: Water in/out 12/7°C at 30°C ambient.
- 3 Figures based on standard unit, for units fitted with optional pump packages, please contact Airedale.

**The Sound Pressure data quoted is only valid in free field conditions, where the unit is installed on a reflective base. If the equipment is placed adjacent to a reflective wall, values may vary to those stated, typically increasing by 3dB for each side added.**



## General Specification

### MECHANICAL DATA

		UCFC75D-2/1	UCFC100D-2/1	UCFC125D-3/1	UCFC150D-3/1	UCFC160D-6/2
<b>Cooling Duty</b>						
DX Cooling Output	(1) kW	73.4	91.2	122.3	141.5	159.3
Nom Input (Compressor only)	(1) kW	25.8	37.4	44.0	57.2	48.1
EER - DX (Mechanical)	(2)	2.84	2.44	2.78	2.47	3.31
Free Cooling	(3) kW	42.0	46.0	67.0	89.0	108.0
Capacity Steps	%	0, 25, 50, 75 & 100	0, 25, 50, 75 & 100	0, 34, 68, 84,100	0, 25, 50, 75 & 100	0, 25, 50, 75 & 100
<b>Dimensions</b>						
H x W x L	mm	2000 x 1300 x 2820	2000 x 1300 x 2820	2000 x 1300 x 3670	2000 x 1300 x 3670	2180 x 2200 x 3870
<b>Weight</b> (4)						
Machine	kg	1220	1260	1610	1670	2210
Operating	kg	1320	1370	1770	1830	2420
<b>Construction - Material / Colour</b>						
<b>Base:</b> Plain Galvanised Steel <b>Panels:</b> Galvanised Sheet Steel, Epoxy Baked Powder Paint, Light Grey (RAL 7035)						
<b>Evaporator</b>						
Stainless Steel Brazed Plate Class 1						
Insulation						
Water Volume	l	2.70	4.00	8.80	11.00	16.20
Total Max. Water Flow	l/s	5.81	7.84	9.68	11.89	12.10
<b>Condenser</b>						
Copper Tube/ Aluminium Fins						
Face Area (Total)	m <sup>2</sup>	5.10	5.10	7.65	7.65	8.42
Nominal Airflow	m <sup>3</sup> /s	7.06	7.06	10.58	10.58	14.70
<b>Fan &amp; Motor</b>						
Sickle Bladed Fan						
Quantity		2	2	3	3	6
Diameter	mm	710	710	710	710	710
Maximum Speed	rpm	900	900	900	900	900
<b>Compressor</b>						
Tandem Scroll						
Quantity		2 + 2	2 + 2	2 + 2	2 + 2	2 + 2
Oil Charge Volume (Total)	l	2 x 3.25 + 2 x 3.25	2 x 3.8 + 2 x 3.8	2 x 6.20 + 2 x 3.80	2 x 6.2 + 2 x 6.20	2 x 6.2 + 2 x 6.20
Oil Type		Polyol Ester				
<b>Refrigeration</b>						
Dual Circuit Electronic Expansion Valve (EEV) R407C						
Refrigerant Control						
Refrigerant Precharged						
Charge (Total)	kg	22 + 22	22 + 22	30 + 30	30 + 30	29 + 29
<b>Connections</b>						
Water Inlet / Outlet - Unit		PN16 DN65	PN16 DN65	PN16 DN65	PN16 DN65	PN16 DN80
Water Drain/Bleed - Evap	in	1/2	1/2	1/2	1/2	1/2
<b>Water System</b>						
Min. System Water Volume	(5) l	377	469	419	727	717
Max. System Operating Press	Bar	10	10	10	10	10
<b>OPTIONAL EXTRAS</b>						
<b>Water Pump</b> (1) In Line Pump						
<b>Single Head or Run/Standby</b>						
Nom External Head - Standard	kPa	143	109	145	122	187
Nom External Head - Larger	kPa	184	150	190	185	254
<b>Twin Head</b>						
Nom External Head - Standard	kPa	100	82	88	89	184
Nom External Head - Larger	kPa	146	125	133	152	254

- (1) Based on 12/7°C water temperature and 30°C ambient with a 20% Ethylene Glycol Water Concentration as quoted in **Capacity Data – DX Mechanical Cooling**, on page 21.  
All performance data is supplied in accordance with BS EN 14511-1:2018
- (2) EER is the DX (Mechanical) Output Duty ÷ Nominal Input.
- (3) Based on flow rate at 12/7°C water temperature and 30°C air on coil, 12°C return water temperature @ 5°C ambient with a 20% Ethylene Glycol Water Concentration.
- (4) Based on standard unit, for units fitted with options, please contact Airedale. Machine weight includes refrigerant charge; operating weight includes refrigerant charge and water volume.
- (5) For minimum system volume calculations refer to **Design Features & Information**, on page 16.

## General Specification

### MECHANICAL DATA

		UCFC75DQ-2/1	UCFC100DQ-3/1	UCFC125DQ-3/1	UCFC150DQ-4/1	UCFC160DQ-6/2
<b>ALL DATA AS D MODEL EXCEPT:</b>						
<b>Cooling Duty</b>						
DX Cooling Output	(1) kW	71.0	96.2	117.7	146.1	153.6
Nom Input (Compressor only)	(1) kW	27.3	34.2	47.0	54.1	47.7
EER - DX (Mechanical)	(2)	2.60	2.81	2.50	2.70	3.22
Free Cooling	(3) kW	39.0	57.0	59.0	77.0	91.0
<b>Dimensions</b>						
H x W x L	mm	2000 x 1300 x 2820	2000 x 1300 x 3670	2000 x 1300 x 3670	2000 x 1300 x 4520	2180 x 2200 x 3870
<b>Weight</b> (4)						
Machine	kg	1220	1550	1610	2020	2410
Operating	kg	1320	1710	1770	2230	2620
<b>Condenser</b>						
Face Area (Total)	m <sup>2</sup>	5.10	7.65	7.65	10.20	8.42
Nominal Airflow	m <sup>3</sup> /s	5.61	8.42	8.42	11.22	11.40
<b>Fan &amp; Motor</b>						
Quantity		2	3	3	4	6
Maximum Speed	rpm	750	750	750	750	750
<b>Refrigeration</b>						
Charge (Total)	kg	22 + 22	30 + 30	30 + 30	40 + 40	29 + 29
<b>OPTIONAL EXTRAS</b>	(5) kg					

		UCFC75DSQ-2/1	UCFC100DSQ-3/1	UCFC125DSQ-4/1	UCFC150DSQ-4/1	UCFC160DSQ-8/2
<b>ALL DATA AS D MODEL EXCEPT:</b>						
<b>Cooling Duty</b>						
DX Cooling Output	(1) kW	65.8	90.0	117.4	133.9	153.8
Nom Input (Compressor only)	(1) kW	30.7	38.2	47.2	62.7	49.9
EER - DX (Mechanical)	(2)	2.14	2.36	2.49	2.14	3.08
Free Cooling	(3) kW	33.0	45.0	66.0	67.0	93.0
<b>Dimensions</b>						
H x W x L	mm	2000 x 1300 x 2820	2000 x 1300 x 3670	2000 x 1300 x 4520	2000 x 1300 x 4520	2180 x 2200 x 4720
<b>Weight</b> (4)						
Machine	kg	1240	1570	1990	2040	2780
Operating	kg	1340	1730	2200	2250	3040
<b>Condenser</b>						
Face Area (Total)	m <sup>2</sup>	5.10	7.65	10.20	10.20	11.22
Nominal Airflow	m <sup>3</sup> /s	5.61	8.42	8.42	11.22	10.80
<b>Fan &amp; Motor</b>						
Quantity		2	3	4	4	8
Maximum Speed	rpm	570	570	570	570	570
<b>Refrigeration</b>						
Charge (Total)	kg	22 + 22	30 + 30	40 + 40	40 + 40	37 + 37
<b>OPTIONAL EXTRAS</b>	(5) kg					

- (1) Based on 12/7°C water temperature and 30°C ambient with a 20% Ethylene Glycol Water Concentration as quoted in **Capacity Data – DX Mechanical Cooling**.  
All performance data is supplied in accordance with BS EN 14511-1:2018
- (2) EER is the DX (Mechanical) Output Duty ÷ Nominal Input.
- (3) Based on flow rate at 12/7°C water temperature and 30°C air on coil, 12°C return water temperature @ 5°C ambient with a 20% Ethylene Glycol Water Concentration.
- (4) Based on standard unit, for units fitted with options, please contact Airedale. Machine weight includes refrigerant charge; operating weight includes refrigerant charge and water volume.
- (5) **For data on options fitted to DQ and DSQ models, please contact Airedale.**

## General Specification

### MECHANICAL DATA

		UCFC180D-6/2	UCFC200D-6/2	UCFC225D-6/2	UCFC250D-8/2	UCFC275D-8/2
<b>Cooling Duty</b>						
DX Cooling Output	(1) kW	179.2	198.6	225.4	256.9	279
Nom Input (Compressor only)	(1) kW	55.6	64.9	75.3	79.9	92.8
EER - DX (Mechanical)	(2)	3.23	3.06	2.99	3.22	3.01
Free Cooling	(3) kW	110.0	111.0	113.0	151.0	152.0
Capacity Steps	%	0, 33, 66, 83,100	0, 35, 70, 85,100	0, 20, 40, 50, 60, 80 & 100	0, 25, 50, 75 & 100	0, 20, 40, 50, 60, 80 & 100
<b>Dimensions</b>						
H x W x L	mm	2180 x 2200 x 3870	2180 x 2200 x 3870	2180 x 2200 x 3870	2180 x 2200 x 4720	2180 x 2200 x 4720
<b>Weight</b> (4)						
Machine	kg	2320	2330	2450	2820	2880
Operating	kg	2530	2540	2670	3100	3200
<b>Construction - Material / Colour</b>						
<b>Base:</b> Plain Galvanised Steel <b>Panels:</b> Galvanised Sheet Steel, Epoxy Baked Powder Paint, Light Grey (RAL 7035)						
<b>Evaporator</b>						
Stainless Steel Brazed Plate Class 1						
Insulation						
Water Volume	l	16.20	18.00	21.60	27.00	27.00
Total Max. Water Flow	l/s	13.50	14.90	16.90	19.20	20.90
<b>Condenser</b>						
Copper Tube/ Aluminium Fins						
Face Area (Total)	m <sup>2</sup>	8.42	8.42	8.42	11.22	11.22
Nominal Airflow	m <sup>3</sup> /s	14.70	14.70	14.70	19.60	19.60
<b>Fan &amp; Motor</b>						
Sickle Bladed Fan						
Quantity		6	6	6	8	8
Diameter	mm	710	710	710	710	710
Maximum Speed	rpm	900	900	900	900	900
<b>Compressor</b>						
Tandem						
Quantity		2 + 2	2 + 2	2 + 2	2 + 2	2 + 2
Oil Charge Volume (Total)	l	2 x 8.0 + 2 x 6.2	2 x 8.0 + 2 x 6.2	2 x 8.0 + 2 x 8.0	2 x 8.0 + 2 x 8.0	2 x 8.0 + 2 x 8.0
Oil Type				Polyol Ester		
<b>Refrigeration</b>						
Dual Circuit Electronic Expansion Valve (EEV) R407C						
Refrigerant Control						
Refrigerant Precharged Charge (Total)	kg	29 + 29	29 + 29	29 + 29	38 + 38	39 + 39
<b>Connections</b>						
Water Inlet / Outlet - Unit		PN16 DN80	PN16 DN80	PN16 DN80	PN16 DN80	PN16 DN100
Water Drain/Bleed - Evap	in	1/2	1/2	1/2	1/2	1/2
<b>Water System</b>						
Min. System Water Volume	(5) l	645	715	811	1156	1004
Max. System Operating Press	Bar	10	10	10	10	10
<b>OPTIONAL EXTRAS</b>						
<b>Water Pump</b> (1) In Line Pump						
<b>Single Head or Run/Standby</b>						
Nom External Head - Standard	kPa	169	160	151	136	163
Nom External Head - Larger	kPa	236	226	217	201	228
<b>Twin Head</b>						
Nom External Head - Standard	kPa	166	156	147	130	157
Nom External Head - Larger	kPa	235	225	215	199	225

- (1) Based on 12/7°C water temperature and 30°C ambient with a 20% Ethylene Glycol Water Concentration as quoted in **Capacity Data – DX Mechanical Cooling**, on page 21.  
All performance data is supplied in accordance with BS EN 14511-1:2018
- (2) EER is the DX (Mechanical) Output Duty ÷ Nominal Input.
- (3) Based on flow rate at 12/7°C water temperature and 30°C air on coil, 12°C return water temperature @ 5°C ambient with a 20% Ethylene Glycol Water Concentration.
- (4) Based on standard unit, for units fitted with options, please contact Airedale. Machine weight includes refrigerant charge; operating weight includes refrigerant charge and water volume.
- (5) For minimum system volume calculations refer to **Design Features & Information**, on page 16.

## General Specification

### MECHANICAL DATA

		UCFC180DQ-6/2	UCFC200DQ-6/2	UCFC225DQ-8/2	UCFC250DQ-8/2	UCFC275DQ-10/2
<b>ALL DATA AS D MODEL EXCEPT:</b>						
<b>Cooling Duty</b>						
DX Cooling Output	(1) kW	173.3	194.2	226.6	251.7	280.4
Nom Input (Compressor only)	(1) kW	58.9	67.6	74.6	83.2	91.9
EER - DX (Mechanical)	(2)	2.94	2.87	3.04	3.03	3.05
Free Cooling	(3) kW	94.0	98.0	122.0	126.0	158.0
<b>Dimensions</b>						
H x W x L	mm	2180 x 2200 x 3870	2180 x 2200 x 3870	2180 x 2200 x 4720	2180 x 2200 x 4720	2180 x 2200 x 5570
<b>Weight</b> (4)						
Machine	kg	2530	2530	3010	3030	3440
Operating	kg	2740	2740	3280	3310	3820
<b>Condenser</b>						
Face Area (Total)	m <sup>2</sup>	8.42	28.42	11.22	11.22	14.03
Nominal Airflow	m <sup>3</sup> /s	11.40	11.40	15.20	15.20	19.00
<b>Fan &amp; Motor</b>						
Quantity		6	6	8	8	10
Maximum Speed	rpm	750	750	750	750	750
<b>Refrigeration</b>						
Charge (Total)	kg	29 + 29	29 + 29	37 + 37	38 + 38	46 + 46
<b>OPTIONAL EXTRAS</b>	(5) kg					

		UCFC180DSQ-8/2	UCFC200DSQ-8/2	UCFC225DSQ-10/2	UCFC250DSQ-10/2	UCFC275DSQ-12/2
<b>ALL DATA AS D MODEL EXCEPT:</b>						
<b>Cooling Duty</b>						
DX Cooling Output	(1) kW	173.9	194.9	224.5	249.4	279.4
Nom Input (Compressor only)	(1) kW	58.6	67.2	75.8	84.6	92.5
EER - DX (Mechanical)	(2)	2.97	2.90	2.96	2.95	3.02
Free Cooling	(3) kW	95.0	98.0	120.0	125.0	146.0
<b>Dimensions</b>						
H x W x L	mm	2180 x 2200 x 4720	2180 x 2200 x 4720	2180 x 2200 x 5570	2180 x 2200 x 5570	2180 x 2200 x 6420
<b>Weight</b> (4)						
Machine	kg	2890	2900	3390	3400	3820
Operating	kg	3150	3170	3710	3730	4260
<b>Condenser</b>						
Face Area (Total)	m <sup>2</sup>	11.22	11.22	14.03	14.03	16.83
Nominal Airflow	m <sup>3</sup> /s	10.80	10.80	13.50	13.50	16.20
<b>Fan &amp; Motor</b>						
Quantity		8	8	10	10	12
Maximum Speed	rpm	570	570	570	570	570
<b>Refrigeration</b>						
Charge (Total)	kg	37 + 37	37 + 37	45 + 45	45 + 45	54 + 54
<b>OPTIONAL EXTRAS</b>	(5) kg					

- (1) Based on 12/7°C water temperature and 30°C ambient with a 20% Ethylene Glycol Water Concentration as quoted in **Capacity Data – DX Mechanical Cooling**.  
All performance data is supplied in accordance with BS EN 14511-1:2018
- (2) EER is the DX (Mechanical) Output Duty ÷ Nominal Input.
- (3) Based on flow rate at 12/7°C water temperature and 30°C air on coil, 12°C return water temperature @ 5°C ambient with a 20% Ethylene Glycol Water Concentration.
- (4) Based on standard unit, for units fitted with options, please contact Airedale. Machine weight includes refrigerant charge; operating weight includes refrigerant charge and water volume.
- (5) **For data on options fitted to DQ and DSQ models, please contact Airedale.**

## General Specification

### MECHANICAL DATA

		UCFC300D-8/2	UCFC330D-10/2	UCFC360D-10/2	UCFC400D-12/2	UCFC450D-12/2
<b>Cooling Duty</b>						
DX Cooling Output	(1) kW	305.3	341.4	366.7	412.8	455.9
Nom Input (Compressor only)	(1) kW	104.0	112	126.1	138.9	155.8
EER - DX (Mechanical)	(2)	2.94	3.05	2.91	2.97	2.93
Free Cooling	(3) kW	153.0	191.0	193.0	231.0	236.0
Capacity Steps	%	0, 25, 50, 75 & 100	0, 19, 33, 52, 67, 85 & 100	0, 17, 33, 50, 67, 83 & 100	0, 18, 33, 51, 67, 85 & 100	0, 17, 33, 50, 67, 83 & 100
<b>Dimensions</b>						
H x W x L	mm	2180 x 2200 x 4720	2180 x 2200 x 5570	2180 x 2200 x 5570	2180 x 2200 x 6420	2180 x 2200 x 6420
<b>Weight</b> (4)						
Machine	kg	2930	3540	3540	3970	4050
Operating	kg	3250	3930	3930	4420	4510
<b>Construction - Material / Colour</b>						
		<b>Base:</b> Plain Galvanised Steel <b>Panels:</b> Galvanised Sheet Steel, Epoxy Baked Powder Paint, Light Grey (RAL 7035)				
<b>Evaporator</b>						
		Stainless Steel Brazed Plate Class 1				
Insulation						
Water Volume	l	28.8	35.1	35.1	39.6	46.8
Total Max. Water Flow	l/s	22.9	25.7	27.4	30.9	34.2
<b>Condenser</b>						
		Copper Tube/ Aluminium Fins				
Face Area (Total)	m <sup>2</sup>	11.22	14.03	14.03	16.83	16.83
Nominal Airflow	m <sup>3</sup> /s	19.60	24.50	24.50	29.40	29.40
<b>Fan &amp; Motor</b>						
		Sickle Bladed Fan				
Quantity		8	10	10	12	12
Diameter	mm	710	710	710	710	710
Maximum Speed	rpm	900	900	900	900	900
<b>Compressor</b>						
		Polyol Ester				
		Dual Circuit				
		Electronic Expansion Valve (EEV) R407C				
Quantity		Tandem 2 + 2	Trio 3 + 3	Trio 3 + 3	Trio 3 + 3	Trio 3 + 3
Oil Charge Volume (Total)	l	2 x 8.0 + 2 x 8.0	3 x 8.0 + 3 x 8.0	3 x 8.0 + 3 x 8.0	3 x 8.0 + 3 x 8.0	3 x 8.0 + 3 x 8.0
<b>Refrigeration</b>						
		Dual Circuit				
		Electronic Expansion Valve (EEV) R407C				
Refrigerant Precharged Charge (Total)	kg	39 + 39	49 + 45	47 + 47	57 + 53	56 + 56
<b>Connections</b>						
Water Inlet / Outlet - Unit		PN16 DN100	PN16 DN100	PN16 DN100	PN16 DN100	PN16 DN100
Water Drain/Bleed - Evap	in	1/2	1/2	1/2	1/2	1/2
<b>Water System</b>						
Min. System Water Volume	(5) l	1374	1168	1122	1337	1395
Max. System Operating Press	Bar	10	10	10	10	10
<b>OPTIONAL EXTRAS</b>						
		In Line Pump				
<b>Water Pump</b> (1)						
<b>Single Head or Run/Standby</b>						
Nom External Head - Standard	kPa	151	138	121	125	108
Nom External Head - Larger	kPa	218	206	190	196	182
<b>Twin Head</b>						
Nom External Head - Standard	kPa	144	129	110	109	87
Nom External Head - Larger	kPa	213	198	180	181	161

- (1) Based on 12/7°C water temperature and 30°C ambient with a 20% Ethylene Glycol Water Concentration as quoted in **Capacity Data – DX Mechanical Cooling**, on page 21.  
All performance data is supplied in accordance with BS EN 14511-1:2018
- (2) EER is the DX (Mechanical) Output Duty ÷ Nominal Input.
- (3) Based on flow rate at 12/7°C water temperature and 30°C air on coil, 12°C return water temperature @ 5°C ambient with a 20% Ethylene Glycol Water Concentration.
- (4) Based on standard unit, for units fitted with options, please contact Airedale. Machine weight includes refrigerant charge; operating weight includes refrigerant charge and water volume.
- (5) For minimum system volume calculations refer to **Design Features & Information**, on page 16.

## General Specification

### MECHANICAL DATA

		UCFC300DQ-10/2	UCFC330DQ-12/2	UCFC360DQ-12/2	UCFC400DQ-14/2	UCFC450DQ-14/2
<b>ALL DATA AS D MODEL EXCEPT:</b>						
<b>Cooling Duty</b>						
DX Cooling Output	(1) kW	303.2	340.7	365.8	414.5	451.9
Nom Input (Compressor only)	(1) kW	105.2	112.4	126.7	137.8	158.0
EER - DX (Mechanical)	(2)	2.88	3.03	2.89	3.01	2.86
Free Cooling	(3) kW	159.0	190.0	219.0	222.0	226.0
<b>Dimensions</b>						
H x W x L	mm	2180 x 2200 x 5570	2180 x 2200 x 6420	2180 x 2200 x 6400	2180 x 2200 x 7270	2180 x 2200 x 7270
<b>Weight</b> (4)						
Machine	kg	3490	4110	4110	4540	4620
Operating	kg	3870	4550	4550	5050	5130
<b>Condenser</b>						
Face Area (Total)	m <sup>2</sup>	14.03	16.83	16.83	19.64	19.64
Nominal Airflow	m <sup>3</sup> /s	19.00	22.80	22.80	26.60	26.60
<b>Fan &amp; Motor</b>						
Quantity		10	12	12	14	14
Maximum Speed	rpm	750	750	750	750	750
<b>Refrigeration</b>						
Charge (Total)	kg	47 + 47	57 + 53	55 + 55	66 + 60	64 + 64
<b>OPTIONAL EXTRAS</b>	(5) kg					

		UCFC300DSQ-12/2	UCFC330DSQ-16/2	UCFC360DSQ-16/2	UCFC400DSQ-16/2	UCFC450DSQ-16/2
<b>ALL DATA AS D MODEL EXCEPT:</b>						
<b>Cooling Duty</b>						
DX Cooling Output	(1) kW	301.8	341.0	366.0	403.6	438.2
Nom Input (Compressor only)	(1) kW	105.9	112.3	126.6	144.4	165.5
EER - DX (Mechanical)	(2)	2.85	3.04	2.89	2.79	2.65
Free Cooling	(3) kW	152.0	190.0	192.0	194.0	195.0
<b>Dimensions</b>						
H x W x L	mm	2180 x 2200 x 6420	2180 x 2200 x 8120	2180 x 2200 x 8120	2180 x 2200 x 8120	2180 x 2200 x 8120
<b>Weight</b> (4)						
Machine	kg	3860	4840	4840	4910	4990
Operating	kg	4300	5400	5400	5470	5560
<b>Condenser</b>						
Face Area (Total)	m <sup>2</sup>	16.83	22.44	22.44	22.44	22.44
Nominal Airflow	m <sup>3</sup> /s	16.20	21.60	21.60	21.60	21.60
<b>Fan &amp; Motor</b>						
Quantity		12	16	16	16	16
Maximum Speed	rpm	570	570	570	570	570
<b>Refrigeration</b>						
Charge (Total)	kg	54 + 54	74 + 68	71 + 71	74 + 68	72 + 72
<b>OPTIONAL EXTRAS</b>	(5) kg					

- (1) Based on 12/7°C water temperature and 30°C ambient with a 20% Ethylene Glycol Water Concentration as quoted in **Capacity Data – DX Mechanical Cooling**.  
All performance data is supplied in accordance with BS EN 14511-1:2018
- (2) EER is the DX (Mechanical) Output Duty ÷ Nominal Input.
- (3) Based on flow rate at 12/7°C water temperature and 30°C air on coil, 12°C return water temperature @ 5°C ambient with a 20% Ethylene Glycol Water Concentration.
- (4) Based on standard unit, for units fitted with options, please contact Airedale. Machine weight includes refrigerant charge; operating weight includes refrigerant charge and water volume.
- (5) **For data on options fitted to DQ and DSQ models, please contact Airedale.**

## General Specification

### ELECTRICAL DATA

		UCFC75D-2/1	UCFC100D-2/1	UCFC125D-3/1	UCFC150D-3/1	UCFC160D-6/2
<b>Unit Data</b> (1)						
Nominal Run Amps	A	50	62	79	93	99
Maximum Start Amps	A	140	167	217	246	252
Rec Mains Fuse Size	A	63	80	125	125	125
Mains Supply	VAC			400V / 3PH / 50 Hz		
Max Mains Incoming Cable Size	mm <sup>2</sup>	70 (direct to MCCB)	70 (direct to MCCB)	70 (direct to MCCB)	70 (direct to MCCB)	Direct to Bus Bar
Permanent Supply	VAC			230V / 1PH + N / 50 Hz		
Rec Permanent Fuse Size	A	16	16	16	16	16
Max Permanent Incoming Cable Size	mm <sup>2</sup>			4 mm <sup>2</sup> terminals		
Control Circuit	VAC			24V/230VAC		
<b>Evaporator</b>						
Immersion Heater Rating	W	40	40	80	80	100
<b>External Trace Heating</b>						
Available (fitted by others)	W	500	500	500	500	500
<b>Fan &amp; Motor - Per Fan</b>						
Quantity		2	2	3	3	6
Full Load Amps	A	1.75	1.75	1.75	1.75	1.75
Locked Rotor Amps	A	6.20	6.20	6.20	6.20	6.20
Motor Size	kW	0.98	0.98	0.98	0.98	0.98
<b>Compressor - Per Compressor</b> (1)						
Quantity		4	4	2 + 2	4	4
Motor Size	kW	6.2	8.1	8.1 / 11.7	11.7	11.7
Nominal Run Amps	A	11.7	14.6	14.6 / 22.0	22.0	22.0
Oil Heater Rating	W	65.0	65.0	65.0 / 75.0	75.0	75.0
Start Amps	(2) A	98.0	120.0	120.0 / 175.0	175.0	175.0
Type Of Start				Direct on line		
<b>OPTIONAL EXTRAS</b>						
<b>Power Factor Correction</b> (1)						
Nominal Run Amps	A	48	55	71	85	91
Maximum Start Amps	(2) A	140	167	217	246	252
Recommended Mains Fuse	A	63	80	125	125	125
Compressor Nominal Run Amps - Per Compressor	A	4 x 11	4 x 13	2 x 20 / 2 x 13	4 x 20	4 x 20
<b>Electronic Soft-Start</b> (1)						
Nominal Run Amps	A	50	62	79	93	99
Maximum Start Amps	(2) A	97	119	147	176	182
Recommended Mains Fuse	A	63	80	125	125	125
<b>Water Pump</b> (1)						
<b>Single Head or Run/Standby - Standard</b>						
Unit Nominal Run Amps	A	55	67	86	98	113
Recommended Mains Fuse	A	80	100	125	125	160
Motor Size	kW	2.2	2.2	3.0	3.0	7.5
Full Load Amps	A	4.8	4.8	6.8	6.8	14.7
<b>Single Head or Run/Standby -Larger</b>						
Unit Nominal Run Amps	A	57	69	85	108	120
Recommended Mains Fuse	A	80	100	125	125	160
Motor Size	kW	3.0	3.0	7.5	7.5	11
Full Load Amps	A	6.8	6.8	15.5	15.5	21.4
<b>Twin Head - Standard</b>						
Unit Nominal Run Amps	A	56	68	85	99	113
Recommended Mains Fuse	A	80	100	125	125	160
Motor Size	kW	3.0	3.0	3.0	3.0	7.5
Full Load Amps	A	6.1	6.1	6.1	6.1	14.7
<b>Twin Head - Larger</b>						
Unit Nominal Run Amps	A	56	70	87	102	120
Recommended Mains Fuse	A	80	100	125	125	160
Motor Size	kW	3.0	4.0	4.0	4.0	11
Full Load Amps	A	6.1	7.7	7.7	7.7	21.4

(1) Based at 12/7°C water and 30°C ambient with standard ac type fans.

(2) Starting amps refers to the Star connection only with standard ac type fans.

## General Specification

### ELECTRICAL DATA

		UCFC75DQ-2/1	UCFC100DQ-3/1	UCFC125DQ-3/1	UCFC150DQ-4/1	UCFC160DQ-6/2
<b>ALL DATA AS D MODEL EXCEPT:</b>						
<b>Fan &amp; Motor - Per Fan</b>						
Quantity		2	3	3	4	6
Full Load Amps	A	1.15	1.15	1.15	1.15	1.15
Locked Rotor Amps	A	2.10	2.10	2.10	2.10	2.10
Motor Size	kW	0.68	0.68	0.68	0.68	0.70

		UCFC75DSQ-2/1	UCFC100DSQ-3/1	UCFC125DSQ-4/1	UCFC150DSQ-4/1	UCFC160DSQ-8/2
<b>ALL DATA AS D MODEL EXCEPT:</b>						
<b>Fan &amp; Motor - Per Fan</b>						
Quantity		2	3	4	4	8
Full Load Amps	A	0.83	0.83	0.83	0.83	0.83
Locked Rotor Amps	A	1.50	1.50	1.50	1.50	1.50
Motor Size	kW	0.32	0.32	0.32	0.32	0.32



## General Specification

### ELECTRICAL DATA

		UCFC180D-6/2	UCFC200D-6/2	UCFC225D-6/2	UCFC250D-8/2	UCFC275D-8/2
<b>Unit Data</b> (1)						
Nominal Run Amps	A	109	121	131	146	160
Maximum Start Amps	A	297	358	368	383	440
Rec Mains Fuse Size	A	160	160	200	200	200
Mains Supply	VAC	400V / 3PH / 50 Hz				
Max Mains Incoming Cable Size	mm <sup>2</sup>	Direct to Bus Bar				
Permanent Supply	VAC	230V / 1PH + N / 50 Hz				
Rec Permanent Fuse Size	A	16	16	16	16	16
Max Permanent Incoming Cable Size	mm <sup>2</sup>	4 mm <sup>2</sup> terminals				
Control Circuit	VAC	24V/230VAC				
<b>Evaporator</b>						
Immersion Heater Rating	W	100	100	100	100	100
<b>External Trace Heating</b>						
Available (fitted by others)	W	500	500	500	500	500
<b>Fan &amp; Motor - Per Fan</b>						
Quantity		6	6	6	8	8
Full Load Amps	A	1.75	1.75	1.75	1.75	1.75
Locked Rotor Amps	A	6.20	6.20	6.20	6.20	6.20
Motor Size	kW	0.98	0.98	0.98	0.98	0.98
<b>Compressor - Per Compressor</b> (1)						
Quantity		2 + 2	2 + 2	2 + 2	4	2 + 2
Motor Size	kW	15.0 / 11.7	18.2 / 11.7	18.2 / 15.0	18.2	22.8 / 18.2
Nominal Run Amps	A	27.0 / 22.0	33.0 / 22.0	33.0 / 27.0	33.0	40.0 / 33.0
Oil Heater Rating	W	130.0 / 75.0	130.0 / 75.0	130.0 / 130.0	130.0	130.0 / 130.0
Start Amps	(2) A	215.0 / 175.0	270.0 / 175.0	270.0 / 215.0	270.0	320.0 / 270.0
Type Of Start		Direct on line				
<b>OPTIONAL EXTRAS</b>						
<b>Power Factor Correction</b> (1)						
Nominal Run Amps	A	99	111	119	134	146
Maximum Start Amps	(2) A	290	351	359	374	430
Recommended Mains Fuse	A	125	160	160	200	200
Compressor Nominal Run Amps - Per Compressor	A	2 x 24/2 x 20	2 x 30/2 x 20	2 x 30/2 x 24	4 x 30	2 x 36 / 2 x 30
<b>Electronic Soft-Start</b> (1)						
Nominal Run Amps	A	109	121	131	146	160
Maximum Start Amps	(2) A	211	250	260	275	312
Recommended Mains Fuse	A	160	160	200	200	200
<b>Water Pump</b> (1)						
<b>Single Head or Run/Standby - Standard</b>						
Unit Nominal Run Amps	A	123	135	145	161	174
Recommended Mains Fuse	A	160	200	200	200	250
Motor Size	kW	7.5	7.5	7.5	7.5	7.5
Full Load Amps	A	14.7	14.7	14.7	14.7	14.7
<b>Single Head or Run/Standby - Larger</b>						
Unit Nominal Run Amps	A	130	142	152	167	181
Recommended Mains Fuse	A	160	200	200	200	250
Motor Size	kW	11	11	11	11	11
Full Load Amps	A	21.4	21.4	21.4	21.4	21.4
<b>Twin Head - Standard</b>						
Unit Nominal Run Amps	A	123	135	145	161	174
Recommended Mains Fuse	A	160	200	200	200	250
Motor Size	kW	7.5	7.5	7.5	7.5	7.5
Full Load Amps	A	14.7	14.7	14.7	14.7	14.7
<b>Twin Head - Larger</b>						
Unit Nominal Run Amps	A	130	142	152	167	181
Recommended Mains Fuse	A	160	200	200	200	250
Motor Size	kW	11	11	11	11	11
Full Load Amps	A	21.4	21.4	21.4	21.4	21.4

(1) Based at 12/7°C water and 30°C ambient with standard ac type fans.

(2) Starting amps refers to the Star connection only with standard ac type fans.

## General Specification

### ELECTRICAL DATA

		UCFC180DQ-6/2	UCFC200DQ-6/2	UCFC225DQ-8/2	UCFC250DQ-8/2	UCFC275DQ-10/2
<b>ALL DATA AS D MODEL EXCEPT:</b>						
<b>Fan &amp; Motor - Per Fan</b>						
Quantity		6	6	8	8	10
Full Load Amps	A	1.15	1.15	1.15	1.15	1.15
Locked Rotor Amps	A	2.10	2.10	2.10	2.10	2.10
Motor Size	kW	0.70	0.70	0.70	0.70	0.70

		UCFC180DSQ-8/2	UCFC200DSQ-8/2	UCFC225DSQ-10/2	UCFC250DSQ-10/2	UCFC275DSQ-12/2
<b>ALL DATA AS D MODEL EXCEPT:</b>						
<b>Fan &amp; Motor - Per Fan</b>						
Quantity		8	8	10	10	12
Full Load Amps	A	0.83	0.83	0.83	0.83	0.83
Locked Rotor Amps	A	1.50	1.50	1.50	1.50	1.50
Motor Size	kW	0.32	0.32	0.32	0.32	0.32

## General Specification

### ELECTRICAL DATA

		UCFC300D-8/2	UCFC330D-10/2	UCFC360D-10/2	UCFC400D-12/2	UCFC450D-12/2
<b>Unit Data</b> (1)						
Nominal Run Amps	A	173	198	216	240	260
Maximum Start Amps	A	454	435	453	520	540
Rec Mains Fuse Size	A	250	250	315	315	355
Mains Supply	VAC	400V / 3PH / 50 Hz				
Max Mains Incoming Cable Size	mm <sup>2</sup>	Direct to Bus Bar				
Permanent Supply	VAC	230V / 1PH + N / 50 Hz				
Rec Permanent Fuse Size	A	16	16	16	16	16
Max Permanent Incoming Cable Size	mm <sup>2</sup>	4 mm <sup>2</sup> terminals				
Control Circuit	VAC	24V/230VAC				
<b>Evaporator</b>						
Immersion Heater Rating	W	100	100	100	100	100
<b>External Trace Heating</b>						
Available (fitted by others)	W	500	500	500	500	500
<b>Fan &amp; Motor - Per Fan</b>						
Quantity		8	10	10	12	12
Full Load Amps	A	1.75	1.75	1.75	1.75	1.75
Locked Rotor Amps	A	6.20	6.20	6.20	6.20	6.20
Motor Size	kW	0.98	0.98	0.98	0.98	0.98
<b>Compressor - Per Compressor</b> (1)						
Quantity		4	3 + 3	6	3 + 3	6
Motor Size	kW	22.8	18.2 / 15.0	18.2	22.8 / 18.2	22.8
Nominal Run Amps	A	40.0	33.0 / 27.0	33.0	40.0 / 33.0	40.0
Oil Heater Rating	W	130.0	130.0 / 130.0	130.0	130.0 / 130.0	130.0
Start Amps	(2) A	320.0	270.0 / 215.0	270.0	320.0 / 270.0	320.0
Type Of Start		Direct on line				
<b>OPTIONAL EXTRAS</b>						
<b>Power Factor Correction</b>						
Nominal Run Amps	(1) A	442	420	438	503	521
Maximum Start Amps	(2) A	250	250	250	315	315
Recommended Mains Fuse	A	4 x 36	3 x 30 / 3 x 24	6 x 30	3 x 36 / 3 x 30	6 x 36
Compressor Nominal Run Amps - Per Compressor	A	158	180	198	219	237
<b>Electronic Soft-Start</b> (1)						
Nominal Run Amps	A	173	198	216	240	260
Maximum Start Amps	(2) A	326	327	345	392	412
Recommended Mains Fuse	A	250	250	315	315	355
<b>Water Pump</b> (1)						
<b>Single Head or Run/Standby - Standard</b>						
Unit Nominal Run Amps	A	188	212	230	254	275
Recommended Mains Fuse	A	250	315	315	315	355
Motor Size	kW	7.5	7.5	7.5	7.5	7.5
Full Load Amps	A	14.7	14.7	14.7	14.7	14.7
<b>Single Head or Run/Standby - Larger</b>						
Unit Nominal Run Amps	A	195	219	237	261	282
Recommended Mains Fuse	A	250	315	315	315	355
Motor Size	kW	11	11	11	11	11
Full Load Amps	A	21.4	21.4	21.4	21.4	21.4
<b>Twin Head - Standard</b>						
Unit Nominal Run Amps	A	188	212	230	254	275
Recommended Mains Fuse	A	250	315	315	315	355
Motor Size	kW	7.5	7.5	7.5	7.5	7.5
Full Load Amps	A	14.7	14.7	14.7	14.7	14.7
<b>Twin Head - Larger</b>						
Unit Nominal Run Amps	A	195	219	237	261	282
Recommended Mains Fuse	A	250	315	315	315	355
Motor Size	kW	11	11	11	11	11
Full Load Amps	A	21.4	21.4	21.4	21.4	21.4

(1) Based at 12/7°C water and 30°C ambient with standard ac type fans.

(2) Starting amps refers to the Star connection only with standard ac type fans.

## General Specification

### ELECTRICAL DATA

		UCFC300DQ-10/2	UCFC330DQ-12/2	UCFC360DQ-12/2	UCFC400DQ-14/2	UCFC450DQ-14/2
<b>ALL DATA AS D MODEL EXCEPT:</b>						
<b>Fan &amp; Motor - Per Fan</b>						
Quantity		10	12	12	14	14
Full Load Amps	A	1.15	1.15	1.15	1.15	1.15
Locked Rotor Amps	A	2.10	2.10	2.10	2.10	2.10
Motor Size	kW	0.70	0.70	0.70	0.70	0.70

		UCFC300DSQ-12/2	UCFC330DSQ-16/2	UCFC360DSQ-16/2	UCFC400DSQ-16/2	UCFC450DSQ-16/2
<b>ALL DATA AS D MODEL EXCEPT:</b>						
<b>Fan &amp; Motor - Per Fan</b>						
Quantity		12	16	16	16	16
Full Load Amps	A	0.83	0.83	0.83	0.83	0.83
Locked Rotor Amps	A	1.50	1.50	1.50	1.50	1.50
Motor Size	kW	0.32	0.32	0.32	0.32	0.32

## Dimension Data

Unit diagrams can be supplied on request, please contact Airedale.

### SINGLE ROW FANS - /1

### UCFC75 - UCFC150

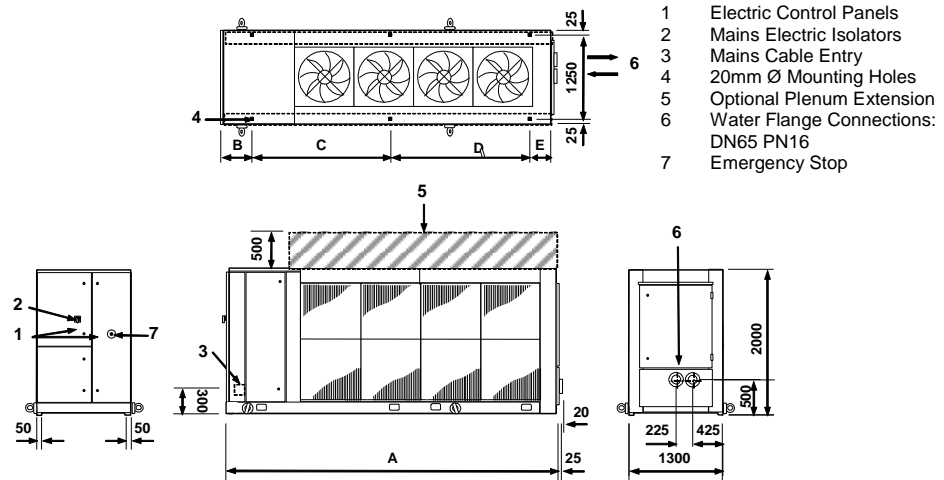

- 1 Electric Control Panels
- 2 Mains Electric Isolators
- 3 Mains Cable Entry
- 4 20mm Ø Mounting Holes
- 5 Optional Plenum Extension
- 6 Water Flange Connections:  
DN65 PN16
- 7 Emergency Stop

Model D		A	B	C	D	E
UCFC75D-2/1	mm	2775	390	1900	(1)	485
UCFC100D-2/1	mm	2775	390	1900	(1)	485
UCFC125D-3/1	mm	3625	390	1825	1135	275
UCFC150D-3/1	mm	3625	390	1825	1135	275
Model DQ		A	B	C	D	E
UCFC75DQ-2/1	mm	2775	390	1900	(1)	485
UCFC100DQ-3/1	mm	3625	390	1825	1135	275
UCFC125DQ-3/1	mm	3625	390	1825	1135	275
UCFC150DQ-4/1	mm	4475	390	1900	1900	285
Model DSQ		A	B	C	D	E
UCFC75DSQ-2/1	mm	2775	390	1900	(1)	485
UCFC100DSQ-3/1	mm	3625	390	1825	1135	275
UCFC125DSQ-4/1	mm	4475	390	1900	1900	285
UCFC150DSQ-4/1	mm	4475	390	1900	1900	285

(1) Have only 4 fixing and 4 point loadings.

## Dimension Data

Unit diagrams can be supplied on request, please contact Airedale.

### DOUBLE ROW FANS - /2

### UCFC160 - UCFC450

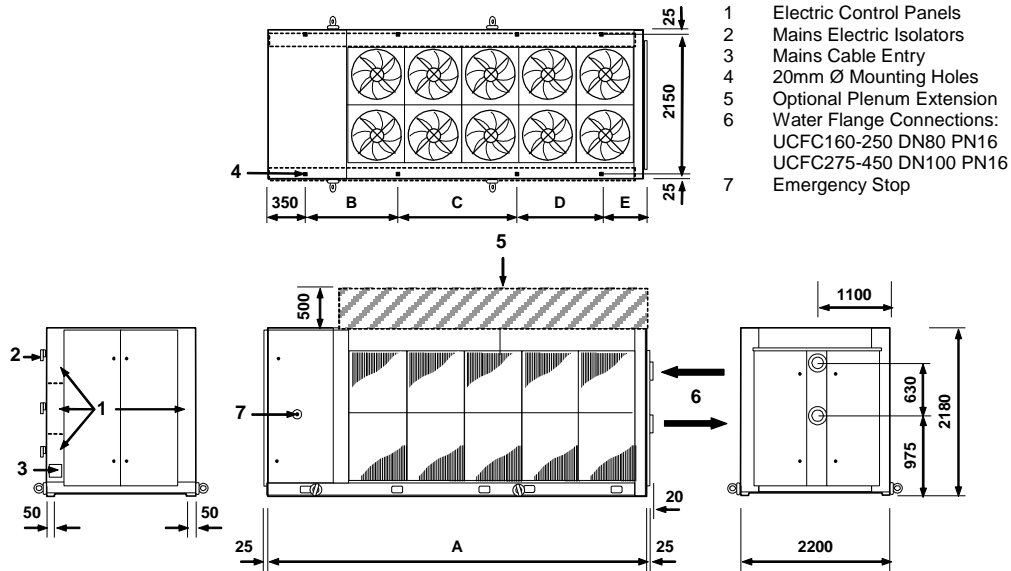

Model D		A	B	C	D	E
UCFC160D - UCFC225D	mm	3800	1350	1475	(1)	625
UCFC250D - UCFC300D	mm	4650	1750	1925	(1)	625
UCFC330D - UCFC360D	mm	5500	1350	1350	1925	525
UCFC400D - UCFC450D	mm	6350	1700	1925	1925	450

Model DQ		A	B	C	D	E
UCFC160DQ - UCFC200DQ	mm	3800	1350	1475	(1)	625
UCFC225DQ - UCFC250DQ	mm	4650	1750	1925	(1)	625
UCFC275DQ - UCFC300DQ	mm	5500	1350	1350	1925	525
UCFC330DQ - UCFC360DQ	mm	6350	1700	1925	1925	450
UCFC400DQ - UCFC450DQ	mm	7200	1700	2700	2000	450

Model DSQ		A	B	C	D	E
UCFC160DSQ - UCFC200DSQ	mm	4650	1750	1925	(1)	625
UCFC225DSQ - UCFC250DSQ	mm	5500	1350	1350	1925	525
UCFC275DSQ - UCFC300DSQ	mm	6350	1700	1925	1925	450
UCFC330DSQ - UCFC450DSQ	mm	8050	1700	2800	2725	525

(1) Have only 6 fixing and 6 point loadings.

## Installation Data

### WEIGHTS, POINT LOADINGS & CENTRE OF GRAVITY (C OF G)

#### SINGLE ROW FANS - /1

#### UCFC75 - UCFC150

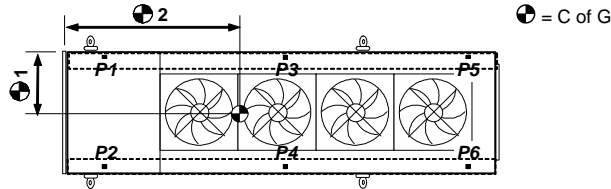

Model D		P1	P2	P3	P4	P5	P6	Operating Weight	C of G1 (mm)	C of G2 (mm)
UCFC75D-2/1	kg	365	365	(1)	(1)	295	295	1320	640	265
UCFC100D-2/1	kg	380	380	(1)	(1)	305	305	1370	640	265
UCFC125D-3/1	kg	405	385	255	245	240	240	1770	640	1450
UCFC150D-3/1	kg	410	410	255	255	250	250	1830	640	1435

Model DQ		P1	P2	P3	P4	P5	P6	Operating Weight	C of G1 (mm)	C of G2 (mm)
UCFC75DQ-2/1	kg	365	365	(1)	(1)	295	295	1320	640	265
UCFC100DQ-3/1	kg	385	385	240	240	230	230	1710	640	1440
UCFC125DQ-3/1	kg	410	390	255	245	235	235	1770	640	1450
UCFC150DQ-4/1	kg	415	415	360	360	340	340	2230	640	1670

Model DSQ		P1	P2	P3	P4	P5	P6	Operating Weight	C of G1 (mm)	C of G2 (mm)
UCFC75DSQ-2/1	kg	375	375	(1)	(1)	295	295	1340	640	265
UCFC100DSQ-3/1	kg	390	390	240	240	235	235	1730	640	1440
UCFC125DSQ-4/1	kg	430	410	350	340	335	335	2200	640	1690
UCFC150DSQ-4/1	kg	430	430	355	355	340	340	2250	640	1670

- (1) Have only 4 fixing and 4 point loadings.
- (2) Based on standard unit, for units fitted with pump options, please contact Airedale.
- (3) Operating weight includes refrigerant charge and system water volume.

## Installation Data

### WEIGHTS, POINT LOADINGS & CENTRE OF GRAVITY (C OF G)

#### DOUBLE ROW FANS - /2

#### UCFC160 - UCFC450

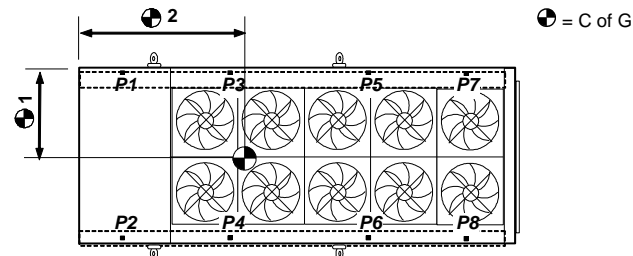

Model D		P1	P2	P3	P4	P5	P6	P7	P8	Operating Weight	C of G1 (mm)	C of G2 (mm)
UCFC160D-6/2	kg	605	605	350	350	(1)	(1)	255	255	2420	1100	1335
UCFC180D-6/2	kg	645	645	360	360	(1)	(1)	260	260	2530	1100	1310
UCFC200D-6/2	kg	645	645	365	365	(1)	(1)	260	260	2540	1100	1315
UCFC225D-6/2	kg	695	695	375	375	(1)	(1)	265	265	2670	1100	1285
UCFC250D-8/2	kg	715	715	455	455	(1)	(1)	380	380	3100	1100	1760
UCFC275D-8/2	kg	735	735	475	475	(1)	(1)	390	390	3200	1100	1765
UCFC300D-8/2	kg	750	750	480	480	(1)	(1)	395	395	3250	1100	1760
UCFC330D-10/2	kg	695	695	465	465	435	435	370	370	3930	1100	2135
UCFC360D-10/2	kg	695	695	465	465	435	435	370	370	3930	1100	2135
UCFC400D-12/2	kg	720	720	535	535	510	510	445	445	4420	1100	2715
UCFC450D-12/2	kg	740	740	545	545	520	520	450	450	4510	1100	2700

Model DQ		P1	P2	P3	P4	P5	P6	P7	P8	Operating Weight	C of G1 (mm)	C of G2 (mm)
UCFC160DQ-6/2	kg	665	665	385	385	(1)	(1)	260	260	2620	1100	1305
UCFC180DQ-6/2	kg	700	700	405	405	(1)	(1)	265	265	2740	1100	1295
UCFC200DQ-6/2	kg	700	700	405	405	(1)	(1)	265	265	2740	1100	1295
UCFC225DQ-8/2	kg	745	745	515	515	(1)	(1)	380	380	3280	1100	1750
UCFC250DQ-8/2	kg	755	755	520	520	(1)	(1)	380	380	3310	1100	1740
UCFC275DQ-10/2	kg	670	670	455	455	425	425	360	360	3820	1100	2140
UCFC300DQ-10/2	kg	690	690	460	460	425	425	360	360	3870	1100	2120
UCFC330DQ-12/2	kg	810	810	545	545	485	485	435	435	4550	1100	2590
UCFC360DQ-12/2	kg	810	810	545	545	485	485	435	435	4550	1100	2590
UCFC400DQ-14/2	kg	850	850	605	605	565	565	505	505	5050	1100	3020
UCFC450DQ-14/2	kg	885	885	610	610	565	565	505	505	5130	1100	2980

Model DSQ		P1	P2	P3	P4	P5	P6	P7	P8	Operating Weight	C of G1 (mm)	C of G2 (mm)
UCFC160DSQ-8/2	kg	690	690	430	430	(1)	(1)	400	400	3040	1100	1810
UCFC180DSQ-8/2	kg	710	710	450	450	(1)	(1)	415	415	3150	1100	1815
UCFC200DSQ-8/2	kg	715	715	455	455	(1)	(1)	415	415	3170	1100	1810
UCFC225DSQ-10/2	kg	655	655	435	435	415	415	350	350	3710	1100	2140
UCFC250DSQ-10/2	kg	655	655	435	435	420	420	355	355	3730	1100	2150
UCFC275DSQ-12/2	kg	705	705	500	500	485	485	440	440	4260	1100	2720
UCFC300DSQ-12/2	kg	720	720	505	505	485	485	440	440	4300	1100	2700
UCFC330DSQ-16/2	kg	840	840	660	660	625	625	575	575	5400	1100	3345
UCFC360DSQ-16/2	kg	840	840	660	660	625	625	575	575	5400	1100	3345
UCFC400DSQ-16/2	kg	850	850	670	670	635	635	580	580	5470	1100	3340
UCFC450DSQ-16/2	kg	870	870	680	680	645	645	585	585	5560	1100	3330

- (1) Have only 6 fixing and 6 point loadings.
- (2) Based on standard unit, for units fitted with pump options, please contact Airedale.
- (3) Operating weight includes refrigerant charge and system water volume.



## Installation Data

### UNIT LIFTING

- **Employ lifting specialists**
- Local codes and regulations relating to the lifting of this type of equipment should be observed
- Use the appropriate spreader bars/lifting slings (provided by others) with the holes/lugs provided
- Attach individual lifting chains to each of the lifting eye bolts/lifting lugs provided; each individual chain must be capable of lifting the whole unit

**IMPORTANT** ▼ **Do not use 1 chain between 2 lifting points to avoid load shift.**

**Only use lifting points provided.**

- Chains/slings **MUST NOT** interfere with the casing or fan assembly to avoid damage
- Lift the unit slowly and evenly

**IMPORTANT** ▼ **If the unit is dropped, it should immediately be checked for damage and reported to Airedale.**

### LIFTING DIMENSIONS

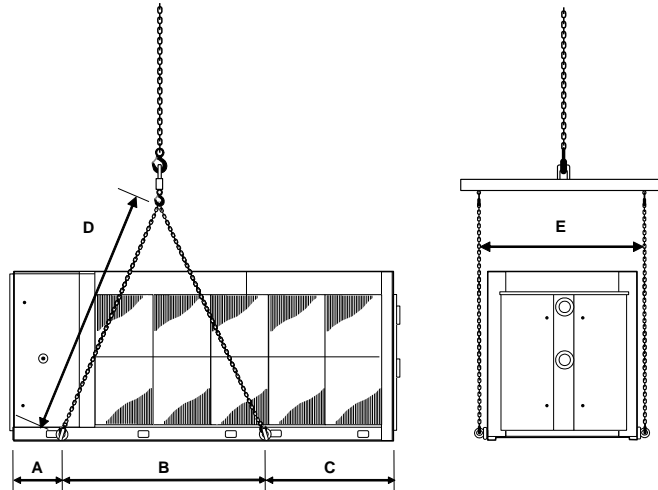

		A	B	C	D	E
2 FANS /1 Row	mm	290	1900	585	2500	1450
3 FANS /1 Row	mm	290	2015	1320	2500	1450
4 FANS /1 Row	mm	290	2870	1315	3000	1450
6 FANS /2 Rows	mm	465	2195	1140	2500	2350
8 FANS /2 Rows	mm	465	2560	1625	2500	2350
10 FANS /2 Rows	mm	465	3135	1900	3500	2350
12 FANS /2 Rows	mm	465	3610	2275	3500	2350
14 FANS /2 Rows	mm	465	4385	2350	4000	2350
16 FANS /2 Rows	mm	465	5035	2550	5000	2350

## Installation Data

### POSITIONING

The installation position should be selected with the following points in mind:

- Position on a stable and even base, levelled to ensure that the compressor operates correctly
- Levelling should be to +/- 5mm
- Where vibration transmission to the building structure is possible, fit spring anti-vibration mounts and flexible water connections
- Observe airflow and maintenance clearances
- Pipework and electrical connections are readily accessible
- Where multiple units are installed, due care should be taken to avoid the discharge air from each unit adversely affecting other units in the vicinity
- Within a side enclosed installation, the fan MUST be higher than the enclosing structure
- Figures in brackets indicate airflow and maintenance clearances for side-enclosed or multiple chiller applications
- Ensure there are no obstructions directly above the fans
- Allow free space above the fans to prevent air recirculation

**CAUTION** ▼ Prior to connecting services, ensure that the equipment is installed and completely level.

The Sound Pressure data quoted (refer to **Sound Data**, on page 38 ) is only valid in free field conditions, where the unit is installed on a reflective base. If the equipment is placed adjacent to a reflective wall, values may vary to those stated in our Performance Data section, typically increasing by 3dB(A) for each side added.

### Airflow & Maintenance Clearances:

- 1 = 1.0m (2.0m)
- 2 = 1.0m (1.8m)

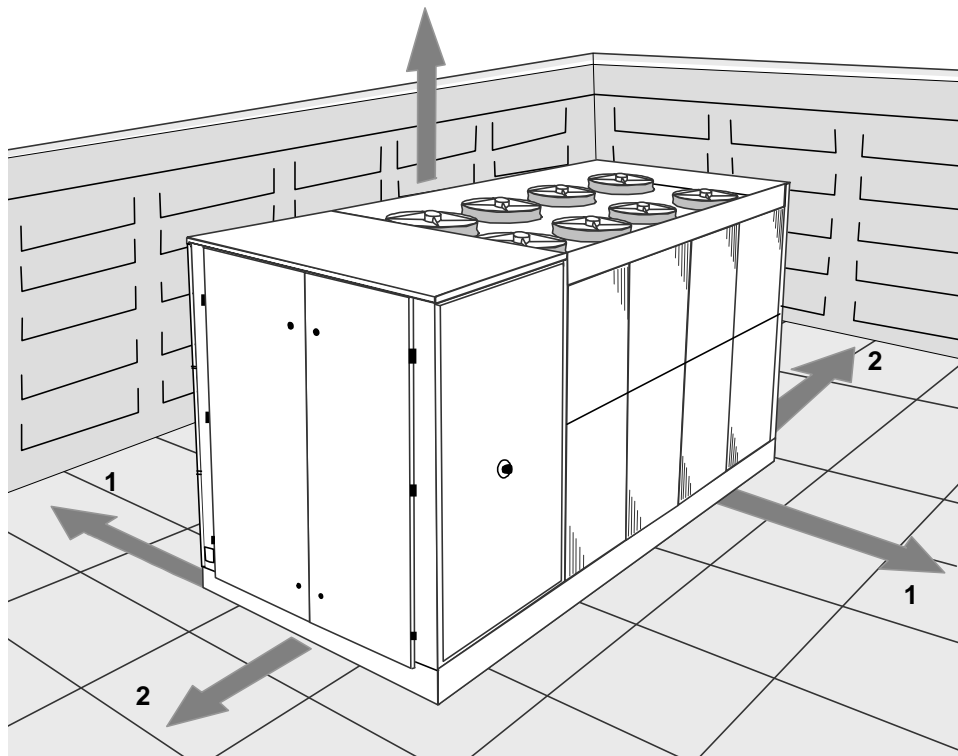

## Installation Data

### ANTI VIBRATION MOUNTING (OPTIONAL)

#### Spring Type

Each mount is coloured to indicate the different loads, refer to AV selection sheet supplied separately for correct allocation.

#### Dimensions

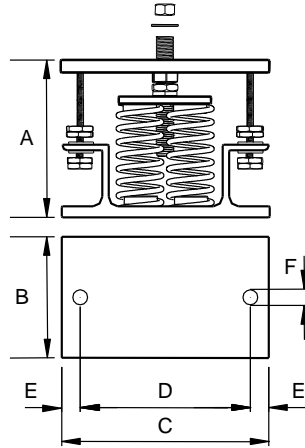

		A <sup>(1)</sup>	B	C	D	E	F $\varnothing$
UCFC 75 – 150	(2) mm	162	110	180	148	16	11
UCFC 160 - 450	(3) mm	162	130	225	186	20	16

- (1) Unloaded dimension
- (2) 2 spring type – UCFC75-150
- (3) 4 spring type – UCFC160-450

#### Components

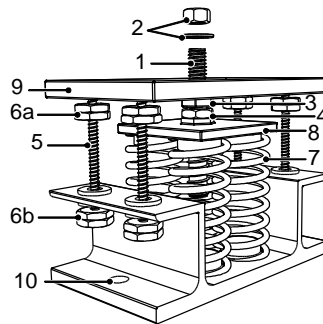

- 1 Locating Screw
- 2 Retaining Nut & Washer
- 3 Levelling Screw
- 4 Levelling Lock Nut
- 5 Retaining Studs
- 6a Upper Retaining Nuts
- 6b Lower Retaining Nuts
- 7 Spring assembly
- 8 Pressure Plate
- 9 Top Plate
- 10 Bolting-down holes

#### Installation

- 1 Locate and secure mount using bolting down holes (10) in base plate.
- 2 Ensure mounts are located in line with the unit base.
- 3 If applicable, remove compressor enclosure covers to allow access to mount fixing holes in the unit base.
- 4 Lock the upper retaining nuts (6a) to the underside of the top plate (9) before a load is applied.
- 5 Remove retaining nut and washer (2), lower the unit onto the mounts and replace retaining nut and washer.
- 6 Beginning with the mount with the largest deflection, adjust the height of each mount using the levelling screw (3).

**CAUTION** **Mountings must be adjusted incrementally in turn. Do not fully adjust 1 mount at a time as this may overload and damage springs.**

- 7 When all mounts are level, lock each into place using the levelling lock nut (4).
- 8 Lock all retaining nuts (6a and 6b) to the extreme ends of the retaining studs (5).

**CAUTION** **Do not connect any services until all anti vibration mounts have been fully adjusted.**

#### Pad Type

#### Components/Installation

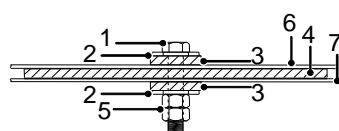

- 1 M16 Bolt (Not Supplied)
- 2 Washer (Not Supplied)
- 3 Fixing Pad 506-063
- 4 A V Pad 506-062
- 5 2 x M16 Nut (Not Supplied)
- 6 Unit Base
- 7 Unit Mounting Plinth

## Installation Data

### WATER SYSTEM

Chilled water pipework and ancillary components must be installed in accordance with:

- National and Local Water supply company standards
- The manufacturer's instructions are followed when fitting ancillary components
- The system water is treated to prevent corrosion and algae forming
- Glycol required as standard, with the correction concentration to suit the lowest ambient the equipment will experience
- The schematic is referred to as a guide to ancillary recommendations

**CAUTION** ▼ **The unit water connections are NOT designed to support external pipework, pipework should be supported separately.**

### STANDARD RECOMMENDED INSTALLATION

#### GENERAL

The following diagram illustrates the minimum component installation requirements. A wide range of optional extras are available to suit various applications, please refer to **Optional Extras – General**, on page 11 for details.

**CAUTION** ▼ **The following installation recommendations should be adhered to. Failure to do this may invalidate the chiller warranty.**

The water flow commissioning valve set is not shown in the diagram, as the valve can be fitted elsewhere within the chilled water circuit.

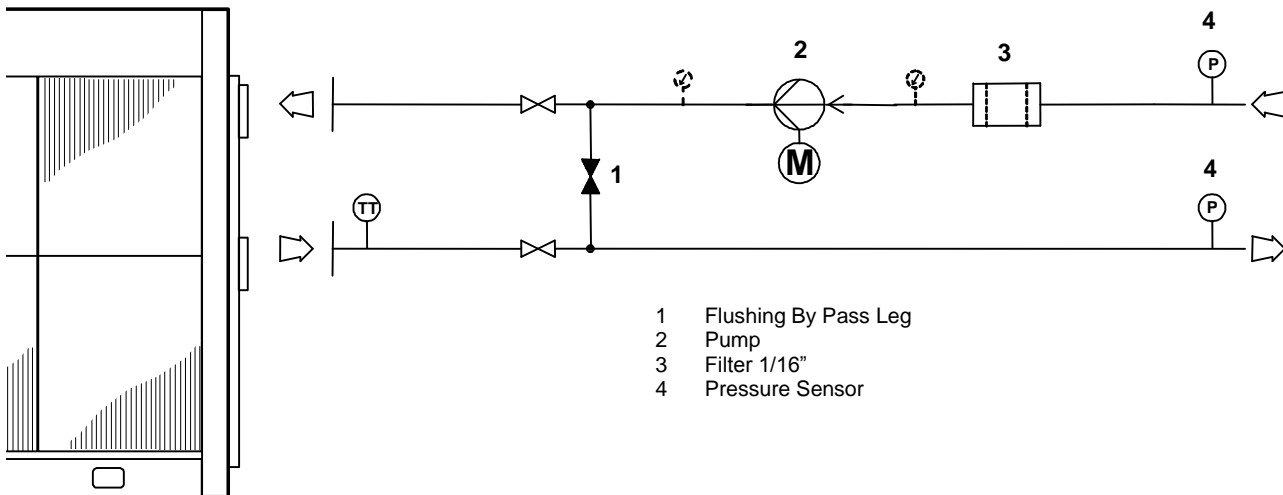

**CAUTION** ▼ **Full design water flow MUST be maintained at all times. Variable water volume is NOT recommended and will invalidate warranty.**

**CAUTION** ▼ **The correct operation of the flow switch is critical if the chiller warranty is to be valid.**

**CAUTION** ▼ **Following components are fitted within the chiller unit as standard:**

- Temperature Sensors
- Drain Point
- Auto Air Vent
- Flow Switch
- 20 Mesh Inlet Filter

## Installation Data

### WATER SYSTEM

#### Component Recommended Requirements

- The recommended requirements to allow commissioning to be carried out correctly are:
- The inclusion of Binder Points adjacent to the flow and return connections, to allow temperature and pressure readings
  - A flow switch or equivalent, fitted adjacent to the water outlet side of the Chiller
  - A water-flow commissioning valve set fitted to the system
  - In multiple chiller installations, 1 commissioning valve set is required per chiller
  - Air vents are to be installed at all high points and where air is likely to be trapped at intermediate points
  - Drain points are to be installed at all low points in the system and in particular adjacent to the unit for maintenance to be carried out
  - Isolating valves should be installed adjacent to all major items of equipment for ease of maintenance
  - Balancing valves can be installed if required to aid correct system balancing
  - All chilled water pipework must be insulated and vapour sealed to avoid condensation
  - If several units are installed in parallel adjacent to each other, reverse return should be applied to avoid unnecessary balancing valves

#### Pump Statement

When installing circulating water pumps or equipment containing them, the following rules should be applied:

- Ensure the system is filled with water then vented and the pump primed with water before running the pump, this is required because the pumped liquid cools the pump bearings and mechanical seal faces
- To avoid cavitation the NPSH (Net Positive Suction Head) incorporating a safety margin of 0.5m head must be available at the pump inlet during operation

#### Interlocks & Protection

Always electrically interlock the operation of the chiller with the pump controls for safety reasons.

**CAUTION**  **Failure to will invalidate the chiller warranty.**

**Do not rely solely on the BMS to protect the chiller against low flow conditions.**

**An evaporator pump interlock MUST be directly wired to the chiller, refer to *Interconnecting Wiring*, on page 62**

### ELECTRICAL

#### General

- As standard the equipment is designed for 400V, 3 phase, 3 wire 50Hz and a separate permanent 230V, 1 phase, 50Hz supply, to all relevant IEE regulations, British standards and IEC requirements
- The control voltage to the interlocks is 24V, always size the low voltage interlock and protection cabling for a maximum voltage drop of 2V
- Avoid large voltage drops on cable runs, particularly low voltage wiring

**CAUTION**  **A fused and isolated electrical supply of the appropriate phase, frequency and voltage should be installed.**

**Wires should be capable of carrying the maximum load current under non-fault conditions at the stipulated voltage.**

**A separately fused, locally isolated, permanent single phase and neutral supply MUST BE FITTED for the compressor oil heater, evaporator trace heating and control circuits, FAILURE to do so will INVALIDATE WARRANTY.**

**To reduce down time, if possible support the above supply with a UPS.**

**ALL work MUST be carried out by technically trained competent personnel.**

**Ensure correct phase rotation.**

**Refer also to *Interlocks & Protection*, above.**

## Installation Data

### INTERCONNECTING WIRING

#### No Pumps

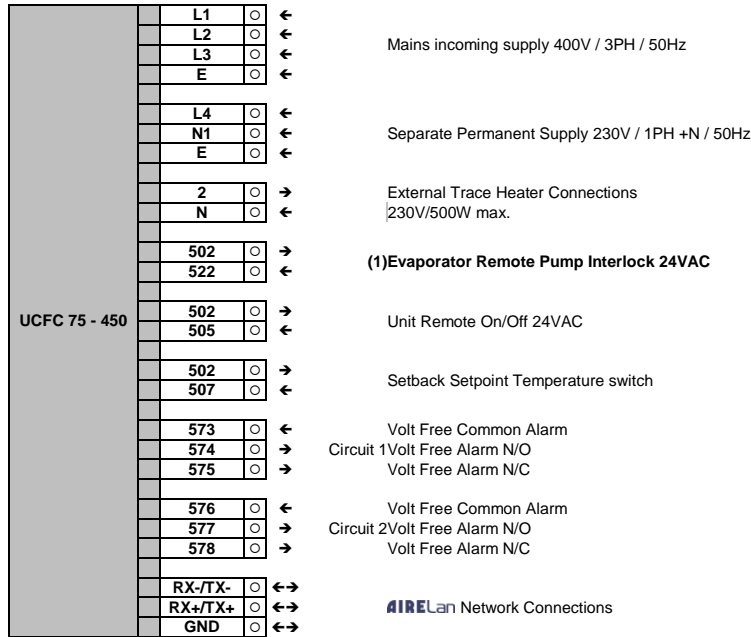

**CAUTION**  **(1) Must be directly wired to the chiller to validate warranty.**

#### With Pumps

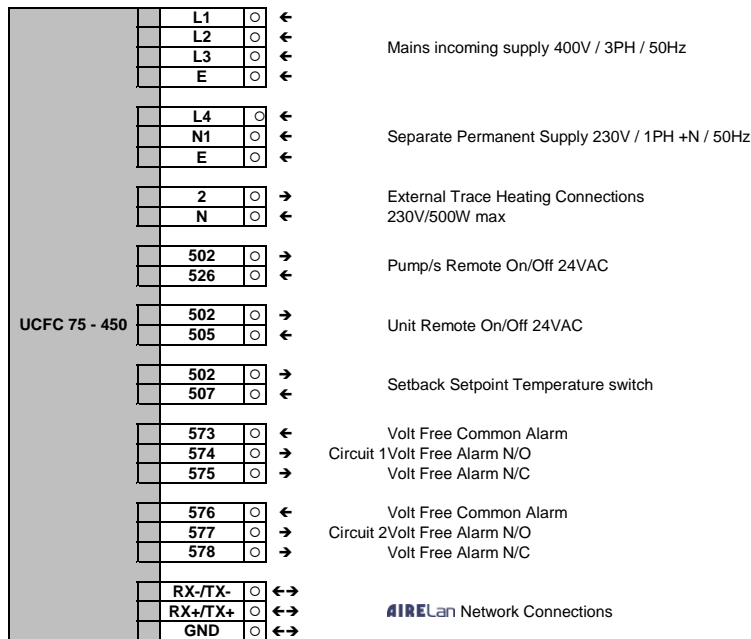

## pLAN Termination

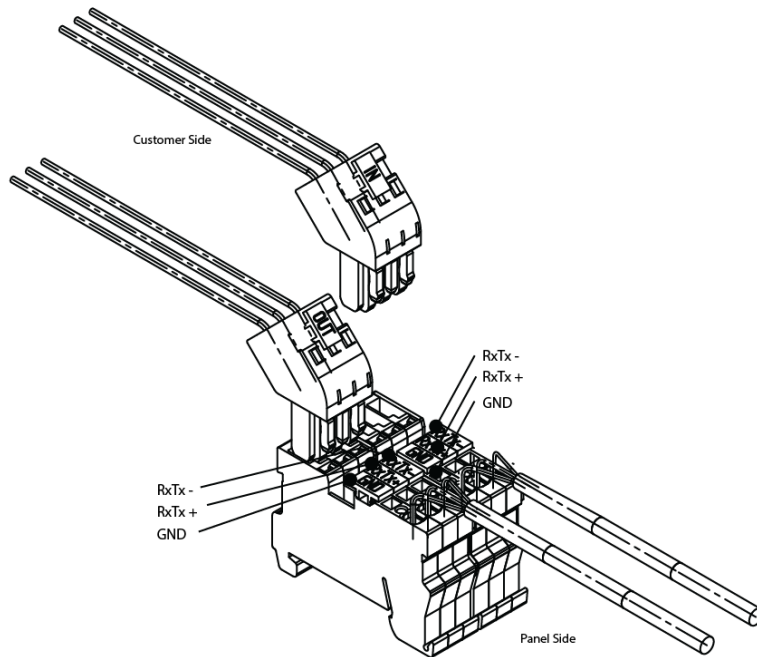

**IMPORTANT:** The plugged termination ensures that the connections are made simultaneously. Failure to attach the cables this way may cause damage to the controller.









**Head Office:**

**Airedale International Air Conditioning Ltd**  
Leeds Road  
Rawdon  
Leeds LS19 6JY  
United Kingdom

**Tel:** +44 (0) 113 239 1000  
**Fax:** +44 (0) 113 250 7219

**e-mail:** [enquiries@airedale.com](mailto:enquiries@airedale.com)  
**website:** [www.airedale.com](http://www.airedale.com)

A  **MODINE** Company

<b>PART NO:</b>	<b>DATE</b>
<b>6259576 (TM E)</b>	09/2008
	02/2011
V1.2.0	02_2013
V1.3.0	07/2014
V1.4.0	10/2014
V1.5.0	11/2015
V1.6.0	12/2015
V1.7.0	01/2016
V1.8.0	03/2016
V1.9.0	06/2018